

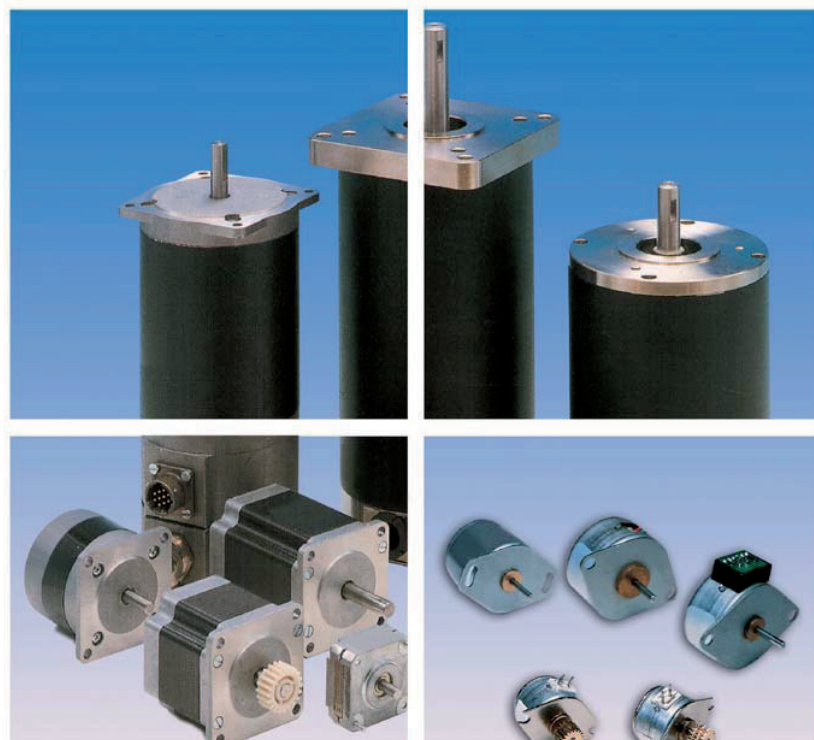

FULLING MOTOR

---



---

CHANGZHOU FULLING MOTOR CO., LTD.

# ***Table of Contents***

## **Theory**

**Stepping Motor**

**DC Brush Motor**

**Small Brushless DC Motor**

## **Hybrid Stepping Motor & Hybrid Stepping Gearmotor**

### **Photo**

<b>Indication</b> .....	A1
1.8° Size 20mm High Torque Hybrid Stepping Motor.....	A2-A3
1.8° Size 28mm High Torque Hybrid Stepping Motor.....	A4-A5
1.8° Size 35mm Hybrid Stepping Motor.....	A6-A7
1.8° Size 39mm Hybrid Stepping Motor.....	A8-A9
0.9° Size 42mm High Torque Hybrid Stepping Motor.....	A10-A12
1.8° Size 42mm High Torque Hybrid Stepping Motor.....	A13-A14
1.8° Size 42mm High Torque Hybrid Stepping Motor With Thread.....	A15
3.6° Size 42mm Hybrid Stepping Motor.....	A16-A17
0.9° Size 57mm High Torque Hybrid Stepping Motor.....	A18-A20
1.8° Size 57mm Hybrid Stepping Motor.....	A21-A23
1.8° Size 57mm High Torque Hybrid Stepping Motor.....	A24-A26
1.8° Size 60mm High Torque Hybrid Stepping Motor.....	A27-A28
1.8° Size 86mm Round High Torque Hybrid Stepping Motor.....	A29
1.8° Size 86mm Round Hybrid Stepping Motor.....	A30-A31
1.8° Size 86mm High Torque Hybrid Stepping Motor.....	A32-A33
1.8° Size 110mm High Torque Hybrid Stepping Motor.....	A34-A35
0.72° ,1.2° ,1.5° ,1.8° Size 110mm Hybrid Stepping Motor.....	A36
0.72° ,1.2° ,1.8° Size 130mm Hybrid Stepping Motor.....	A37
Size 57mm 3-Phase Hybrid Stepping Motor.....	A38
Size 86mm 3-Phase Hybrid Stepping Motor.....	A39-A40
Size 110mm 3-Phase Hybrid Stepping Motor.....	A41
FL57STHJB Stepping Motor with gearbox.....	A42
FL86STHJB Stepping Motor with gearbox.....	A43
Q2HB Series Driver for 2-Phase Hybrid Stepping Motor.....	A44-A45
M Series Driver for 2-Phase Hybrid Stepping Motor.....	A46
Q3HB Series Driver for 3-Phase Hybrid Stepping Motor.....	A47

## **PM Stepping Motor & PM Stepping Gearmotor**

### **Photo**

<b>Indication</b> .....	B1
PM15-20-25 Series.....	B2-B4
PM35/42/49/57 Series.....	B5-B7
PMG25/35 Series.....	B8-B9
42BYG/40JB4K Series.....	B10
20/24/28/30/35BYJ Series.....	B11-B12
25BYZ Series.....	B13-B14
35/57BYZ Series.....	B15-B16
15/20/25/35/42/57BYT Series.....	B17-B18

## **Brushless DC Motor**

### **Photo**

28BL Series.....	C1
33BL Series.....	C2
42BLS Series.....	C3
57BL(S) Series.....	C4
57BLSH Series.....	C5
86BLS Series.....	C6
42BLS-IE.....	C7
57BL(S)-IE.....	C8
24/36/48ZWSK05/10-S.....	C9
24/36/48ZWSK15.....	C10
24/36/48ZWSK20/30-B.....	C11

**DC Brush Motor & Servo Brush Motor**

**Photo**

JFF-M20S/N20PA/N30PA/040S/130SH/(180PH/SH) Series.....D1-D6  
 JRC/JFC/JFK-260SA/280SA Series.....D7-D12  
 JRF/RK-370 Series.....D13  
 JRS-360SM/365SA/380PM/385S/390PM/395SP Series.....D14-D19  
 JRF-500TB/520C Series.....D20-D21  
 JFS-540SM/545SM Series.....D22-D23  
 JRS-540SM/545S/5412SP/550PM/5512SP/555SP Series.....D24-D29  
 JFS-5412PM/550PM/5512PM/555PM Series.....D30-D33  
 JRS-750PM/755PM/7512PM/770PM/7712PM/775PM/9712PM/977PM/9912PM/997PM Series.....D34-D43  
 SB40 Series.....D44  
 SB54 Series.....D45

**PM DC Gearmotor**

**Photo**

**Indication for 25JA3K Series.....E1**  
 25JA3K/2420/2430 Series.....E2-E3  
**Indication for 37JB6K Series.....E4**  
 37JB6K/3530/3540/3650/3657/3324 Series.....E5-E8  
 60JB25K/3650/3657/6075/60105 Series.....E9-E11  
 80JB80K/73110 Series.....E12  
 90JB200K/83125 Series.....E13  
 90JWG200K/83125 Series.....E14  
 24JX5K/2430 Series.....E15  
 28JX10K/2838 Series.....E16  
 36JX10K/3530/3540/3650/3657 Series.....E17-E20

**Coreless DC Motor & Coreless DC Gearmotor**

**Photo**

**Indication.....F1**  
 16/20/22 SKY Coreless motor Series.....F2  
 28 SKY Coreless motor Series.....F3  
 10/12 SKY Coreless Gaemotor Series.....F4  
 16 SKY Coreless Gaemotor Series.....F5  
 20 SKY Coreless Gaemotor Series.....F6

**AC Gearmotor**

**Photo**

**Indication of the model number.....G1**  
 6W 60YY/YN Series.....G2  
 15W 70YY/YN Series.....G3  
 25W 80YY/YN Series.....G4  
 40W 90YY/YN Series.....G5  
 60W 90YY/YN Series.....G6  
 90W 90YY/YN Series.....G7  
 120W/140W 100YY/YN Series.....G8  
 90YN Series Worm Gearmotor.....G9

**AC Moror**

**Photo**

**Indication.....H1**  
 60/70/80 YY/YN Series.....H2  
 90/100 YY/YN Series.....H3  
 42TRY/40JB4K Series.....H4  
 60TRY-J/JB Series.....H5-H6

## Stepper Motor theory

**Motors convert electrical energy into mechanical energy. A stepper motor converts electrical pulses into specific rotational movements. The movement created by each pulse is precise and repeatable, which is why stepper motors are so effective for positioning applications.**

Permanent Magnet stepper motors incorporate a permanent magnet rotor, coil windings and magnetically conductive stators. Energizing a coil winding creates an electromagnetic field with a north and south pole. The stator carries the magnetic field. The magnetic field can be altered by sequentially energizing or "stepping" the stator coils which generates rotary motion.

Figure 1 illustrates a typical step sequence for a two phase motor. In Step 1 phase A of a two phase stator is energized. This magnetically locks the rotor in the position shown, since unlike poles attract. When phase A is turned off and phase B is turned on, the rotor rotates 90° clockwise. In step 3, phase B is turned on but with the polarity reversed from Step 1, this causes another 90° rotation. In Step 4, phase A is turned off and phase B is turned on, with polarity reversed from Step 2. Repeating this sequence causes the rotor to rotate clockwise in 90° steps.

The stepping sequence illustrated in figure 1 is called "one phase on" stepping. A more common method of stepping is "two phase on" where both phases of the motor are always energized. However, only the polarity of phase is switched at a time, as shown in figure 2. With two phase on stepping the rotor aligns itself between the "average" north and "average" south magnetic poles. Since both phases are always on, this method gives 41.4% more torque than "one phase on" stepping.

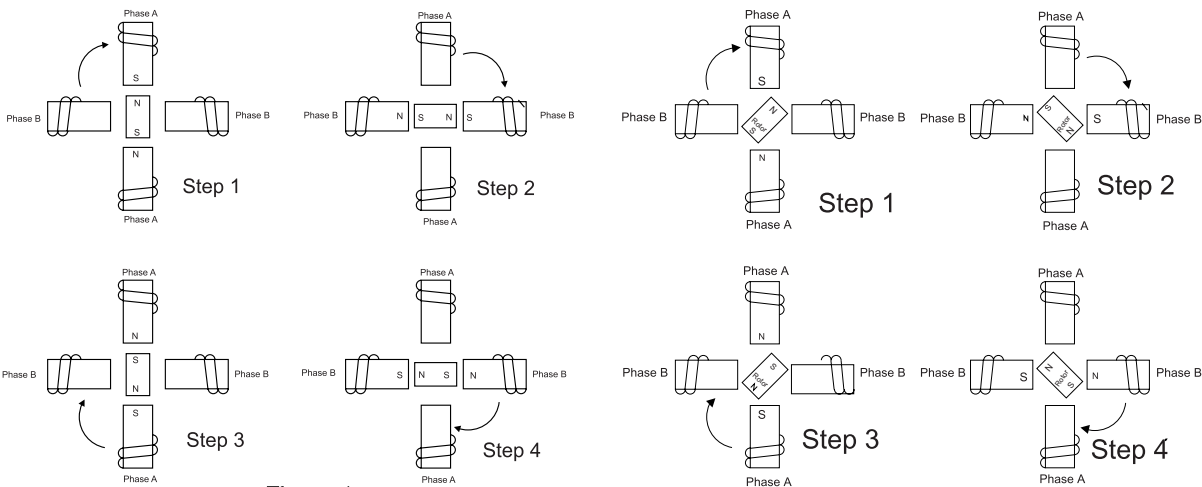
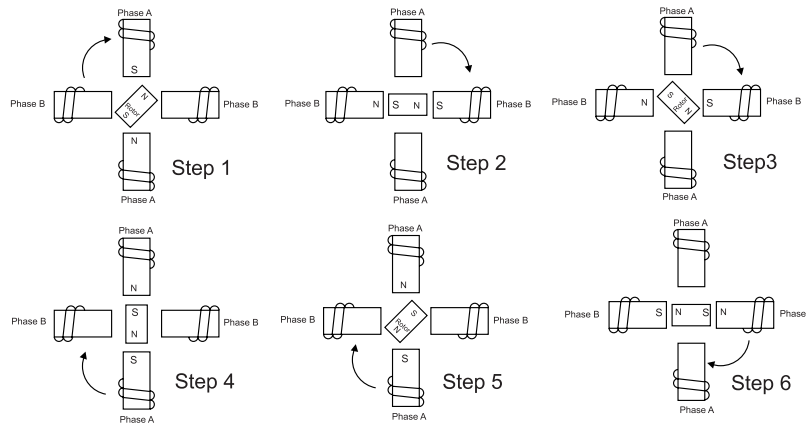

Figure 1

Figure 2

### Half Stepping

The motor can also be "half stepped" by inserting an off state between transitioning phases. This cuts a stepper's full step angle in half. For example, a 90° stepping motor would move 45° on each half step, figure 3. However, half stepping typically results in a 15%-30% loss of torque depending on step rate when compared to the two phase on stepping sequence. Since one of the windings is not energized during each alternating half step there is less electromagnetic force exerted on the rotor resulting in a net loss of torque.



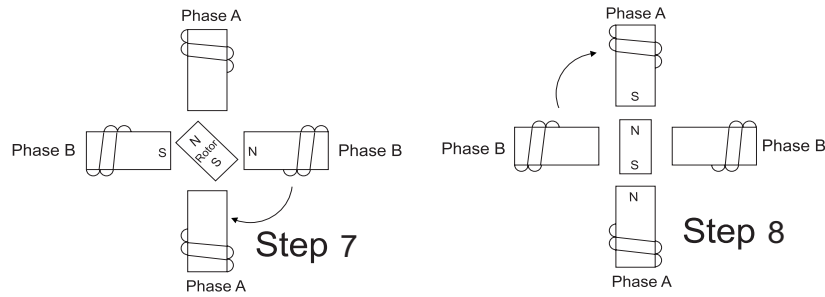

Figure 3. Half-stepping-90° step angle is reduced to 45° with half-stepping.

**DC Brush Motor**

**Principles of operation**

Reference to the chart reveals useful performance information valid for all fulling servomotors.

It shows speed  $n$ , current  $I$ , output power  $P$  and efficiency  $\eta$  plotted against torque  $M$  for a given supply voltage  $U$ . Torque  $M$  is a function of the current  $I$  and the torque constant  $k$  (expressed in Nm/A). The motor develops its maximum torque  $M_s$  at stall ( $n=0$ ), when the current is maximum and determined only by the supply voltage  $U$  and the rotor resistance  $R$ :

$$I_s = U/R$$

$$M_s = I_s \cdot k$$

With increasing speed, an increasing back EMF  $E$  is induced in the armature which tends to reduce the current:

$$I = \frac{U - E}{R}$$

The value of  $E$  is the product of angular speed  $\omega$  (expressed in rad/s) and the torque constant (expressed in V/rad/s= $V_s=Nm/A$ ):

$$E = k \cdot \omega$$

Thus, the supply voltage splits into two parts:  $RI$ , necessary to establish the current  $I$  in the armature, which generates the torque  $M$ , and  $k \cdot \omega$  to overcome the induced voltage, in order to generate the speed  $\omega$ :

$$U = RI + k \cdot \omega$$

No-load speed  $n_0$  is a function of the supply voltage and is reached when  $E$  becomes almost equal to  $U$ ; no-load current  $I_0$  is a function of friction torque:

$$n_0 = \frac{U - RI_0}{k} \cdot \frac{30}{\pi} \quad (\text{rpm})$$

Power output  $P$  is the product of angular speed  $\omega$  and torque  $M$  ( $P = M \cdot \omega$ ); for a given voltage it reaches its maximum  $P_{max}$  at half the stall torque  $M_s$ , where efficiency is close to 50%. The maximum continuous output power is defined by an hyperbola delimiting the continuous and intermittent operation ranges.

Efficiency  $\eta$  is the mechanical to electrical power ratio ( $\eta = P_m / P_{el}$ ). Maximum efficiency  $\eta_{max}$  occurs at relatively high speed. Its value depends upon the ratio of stall torque and friction torque and thus is a function of the supply voltage:

$$\eta_{max} = (1 - \text{SQR}(I_0/I_s))^2$$

The maximum continuous torque depends upon dissipated power ( $I^2R$ ), its maximum value is determined by:

$$M_{max} = K \sqrt{P_{diss}/R_{max}} = K \cdot I_{max} = K \sqrt{\frac{T_{max} - T_{amb}}{R_{max} \cdot R_{th}}}$$

Where  $T_{max}$  is the maximum tolerated armature temperature,  $T_{amb}$  is the ambient temperature,  $R_{max}$  is the rotor resistance at temperature  $T_{max}$  and  $R_{th}$  is the total thermal resistance (rotor-body-ambient).

At a given torque  $M$ , increasing or decreasing the supply voltage will increase or decrease the speed. The speed-torque function varies proportionally to the supply voltage  $U$ .

**Small Brushless DC Motor**

**Principles of operation**

The differences between a DC motor having a mechanical commutation system and a BLDC motor are mainly found in :

- the product concept

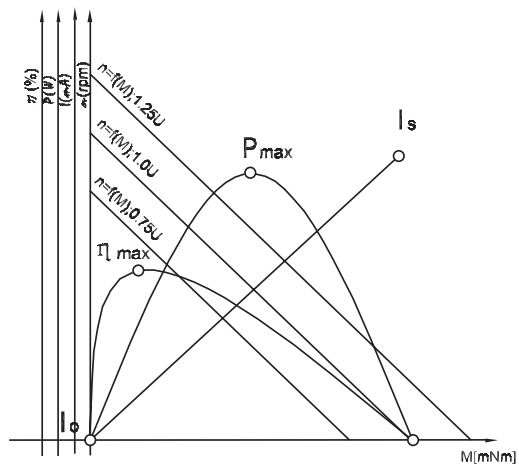



- the commutation of phase currents.

From the user's point of view, brushless DC motors follow the same equations as those with brushes: torque is proportional to current, speed depends on the voltage and the load torque.

**The commutation of brushless motors**

In the conventional DC motor commutation takes place mechanically through the commutator-and-brush system. In a BLDC motor, commutation is done by electronic means. In that case the instantaneous rotor position must be known in order to determine the phases to be energized.

The angular rotor position can be known by:

- using a position sensor (Hall sensor, optical encoder, resolver)
- electronically analyzing the back-EMF of a non-energized winding. This is called sensorless commutation.

**Use of Hall sensors**

In general, BLDC motor have three phase windings. The easiest way is to power two of them at a time, using Hall sensors to know the rotor position. A simple logic allows for optimal energizing of the phases as a function of rotor position, just like the commutator and brushes are doing in the conventional DC motor.

**Use of an encoder or resolver**

The rotor position may also be known by use of an encoder or resolver. Commutation may be done very simply, similar to the procedure with Hall sensors, or it may be more complex by modulating sinusoidal currents in the three phases. This is called vector control, and its advantage is to provide a torque ripple of theoretically zero, as well as a high resolution for precise positioning.

**Use of Back-EMF analysis**

A third option requiring no position sensor is the use of a particular electronic circuit. The motor has only three hook-up wires, the three phase windings are connected in either triangle or star. In the latter case, resistors must be used to generate a zero reference voltage. With this solution the motor includes no sensors or electronic components and it is therefore highly insensitive to hostile environments. For applications such as hand-held tools, where the cable is constantly moved, the fact of just three wires is another advantage.

The functioning of a sensorless motor is easy to understand. In all motors, the relation of back-EMF and torque versus rotor position is the same. Zero crossing of the voltage induced in the non-energized winding corresponds to the position of maximum torque generated by the two energized phases. This point of zero crossing therefore allows to determine the moment when the following commutation should take place depending on motor speed. This time interval is in fact equivalent to the time the motor takes to move from the position of the preceding commutation to the back-EMF zero crossing position. Electronic circuits designed for this commutation function allow for easy operation of sensorless motors.

**Small Brushless DC Motor**

As the back-EMF information is necessary to know the rotor position, sensorless commutation doesn't work with the motor at stall. The only way of starting is to pilot it at low speed like a stepper in open loop.

**Remember:**

- for commutation, position sensors are necessary when operating in incremental mode
- sensorless commutation is recommended only for applications running at constant speed and load.

**Operating principle of BLDC motors:**

It follows the same equations as the DC motor using mechanical commutation except that parameters like iron losses and losses in the drive circuit are no longer negligible in applications where efficiency is of prime importance.

**Iron losses**

They depend on speed and, in the torque formula, may be introduced as viscous friction. The equation for useful motor torque becomes:

$$M_m = k \cdot I_m - k_v \cdot \omega - M_f$$

With  $M_m$  = motor useful torque

$k$  = torque constant

$I_m$  = motor current

$k_v$  = viscous coefficient for iron losses

$\omega$  = angular velocity

$M_f$  = bearing friction

**Losses in the electronics**

The current and voltage required by the motor and the drive circuit to operated at the desired speed and torque depend also on the drive circuit.

As an example, a driver bridge in bipolar technique will reduce the voltage available at the motor terminals by about 1.7V, and the total current must include the consumption of the circuitry.

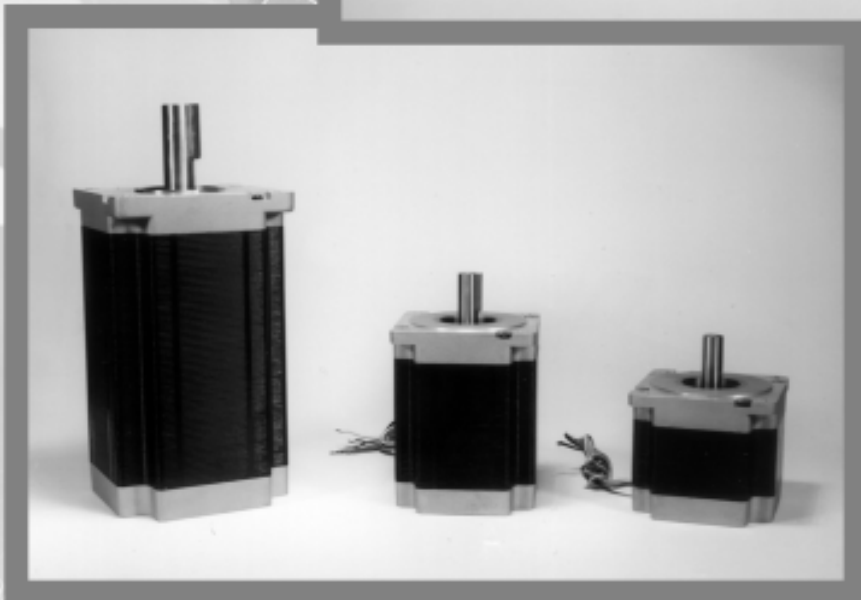
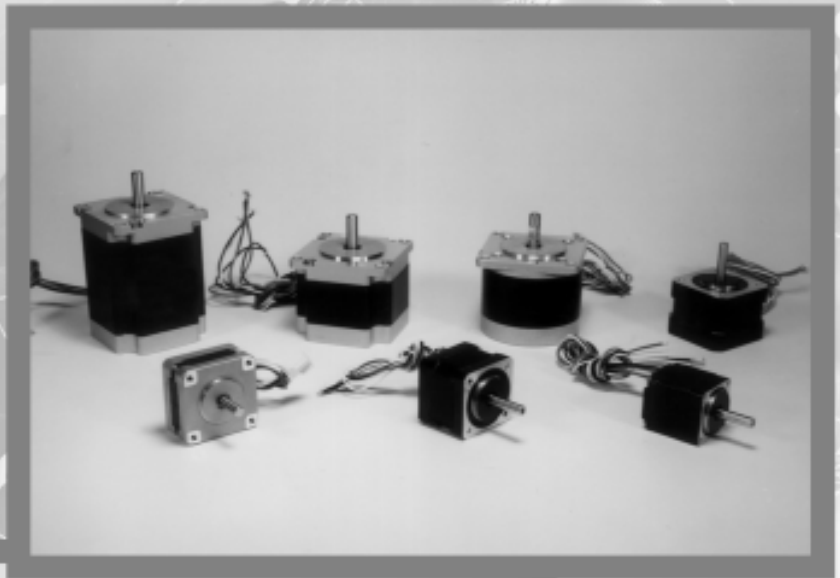
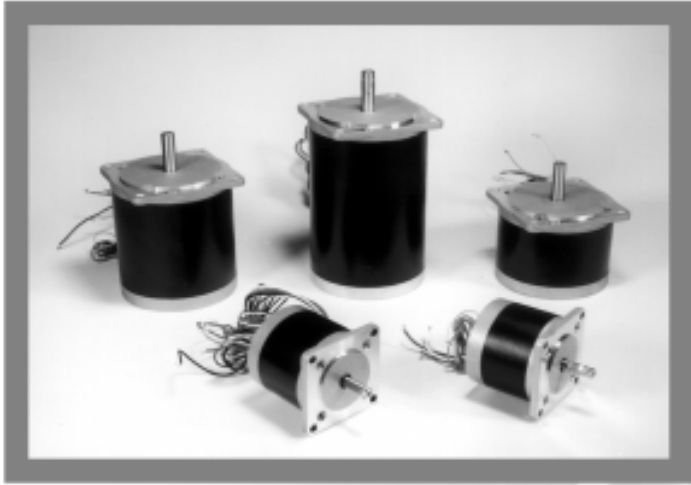

## ● Product Number Code For Hybrid Stepping Motor

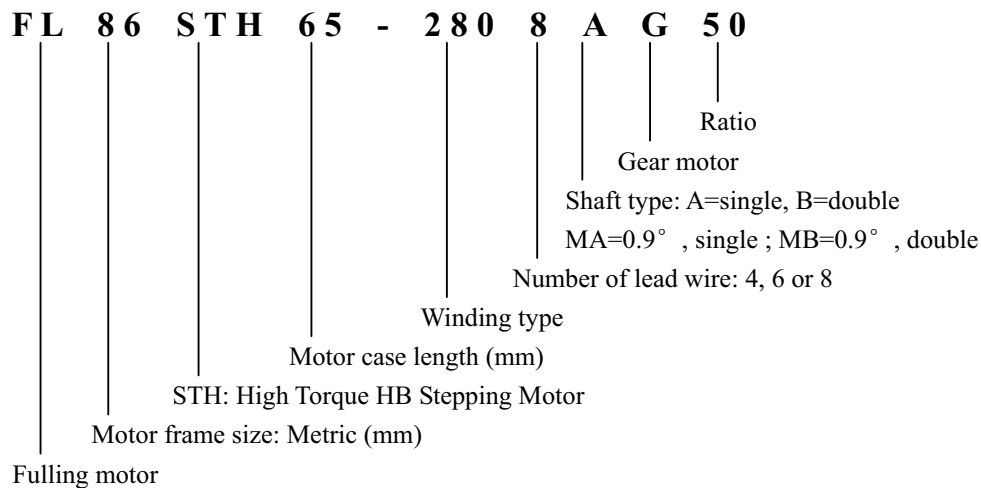
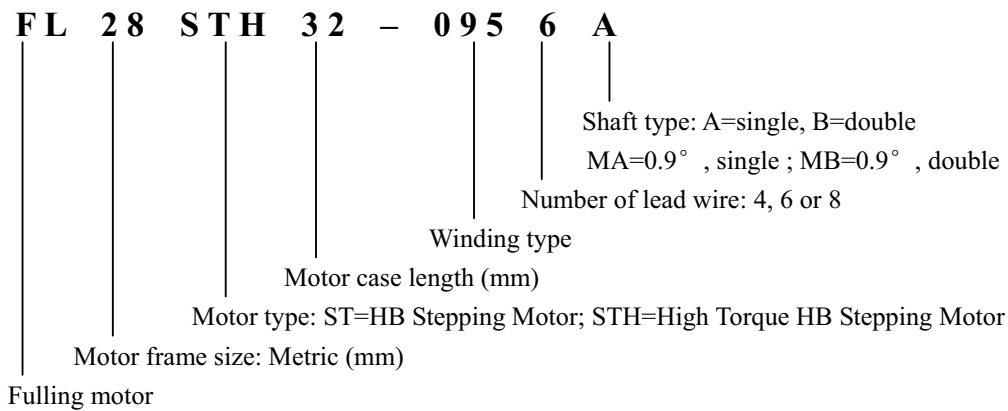

## ● Wiring diagram

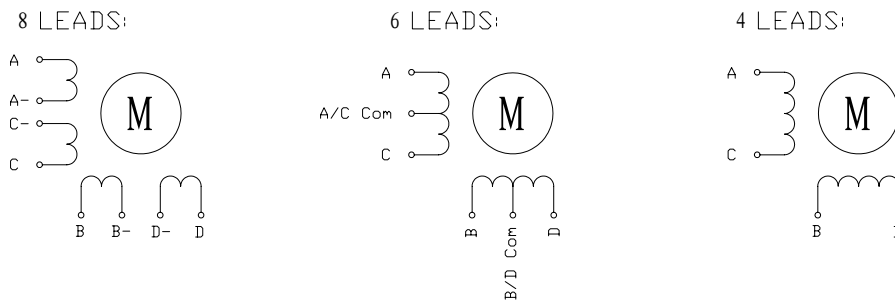

### 8 LEADS:

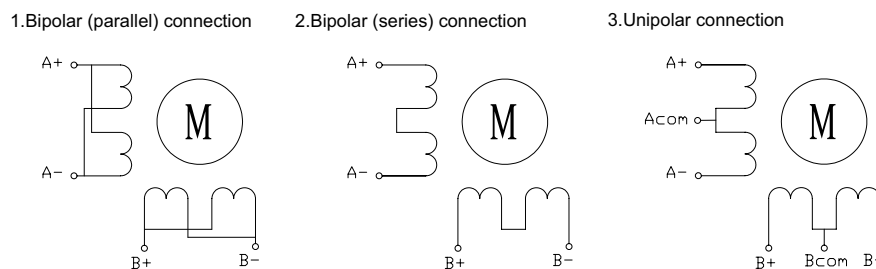



# 1.8° Size 20mm High Torque Hybrid Stepping Motor

A2

Item	Specifications
Step Angle	1.8°
Step Angle Accuracy	±5% (full step, no load)
Resistance Accuracy	±10%
Inductance Accuracy	±20%
Temperature Rise	80° C Max.(rated current,2 phase on)
Ambient Temperature	-20° C~+50° C
Insulation Resistance	100M Ω Min. ,500VDC
Dielectric Strength	500VAC for one minute
Shaft Radial Play	0.02Max. (450 g-load)
Shaft Axial Play	0.08Max. (450 g-load)
Max. radial force	20N
Max. axial force	2N

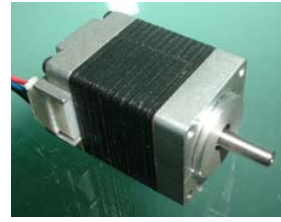

## ● Size 20mm High Torque Hybrid Stepping Motor Specifications

Model No.	Rated Voltage	Current /Phase	Resistance /Phase	Inductance /Phase	Holding Torque	# of Leads	Rotor Inertia	Weight	Length
Single Shaft	V	A	Ω	mH	g.cm		kg-m <sup>2</sup>	kg	mm
FL20STH30-0604A	3.9	0.6	6.5	1.7	180	4	2.0x10 <sup>-7</sup>	0.06	30
FL20STH33-0604A	3.9	0.6	6.5	1.7	180	4	2.0x10 <sup>-7</sup>	0.06	33
FL20STH42-0804A	4.32	0.8	5.4	1.5	300	4	3.6x10 <sup>-7</sup>	0.08	42

## ● Dimension: :

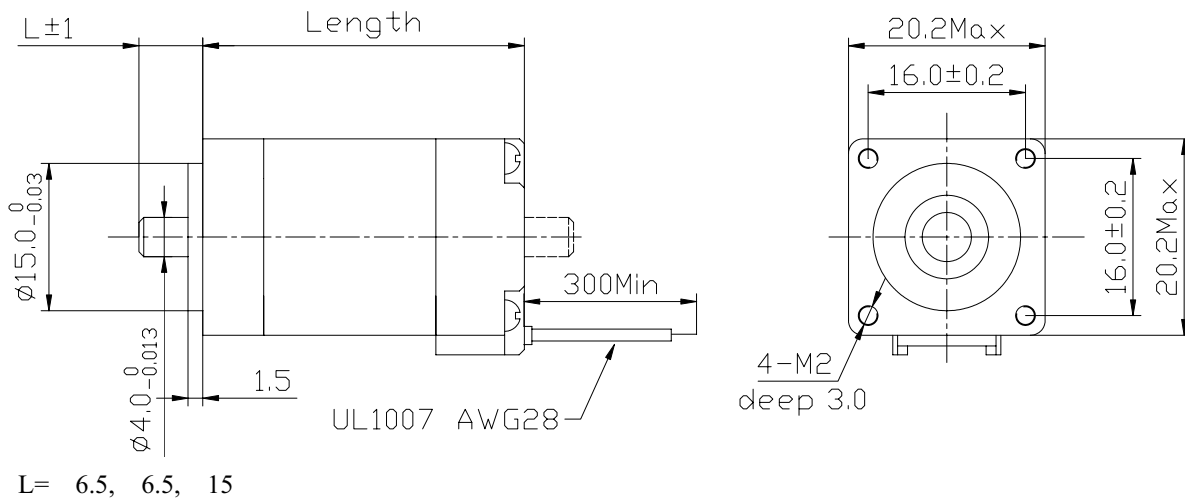

## ● Wiring Diagram:

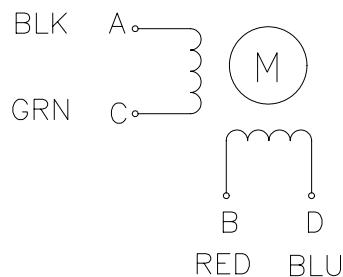

● Pull out torque curve:

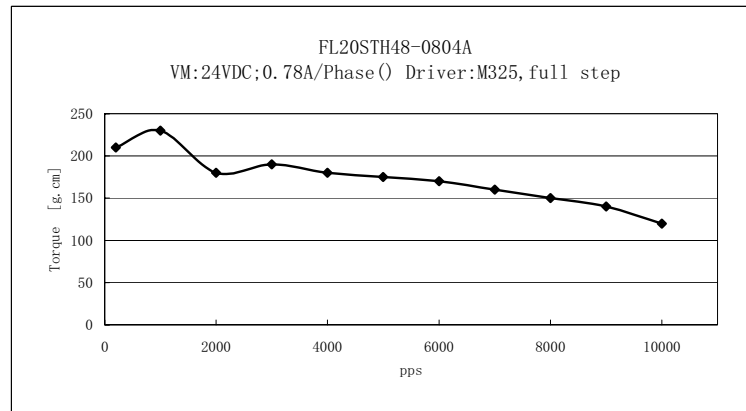
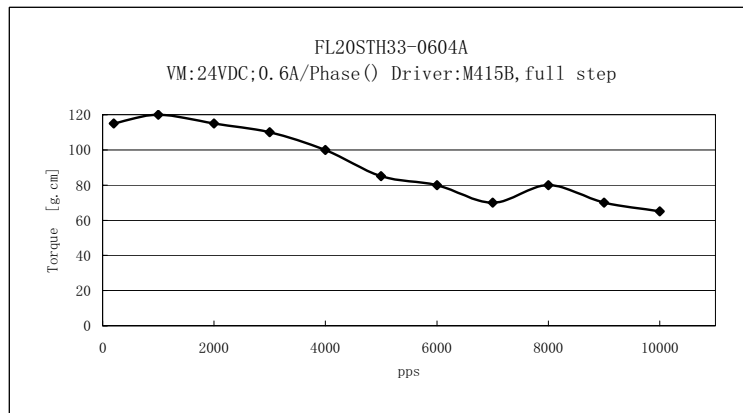
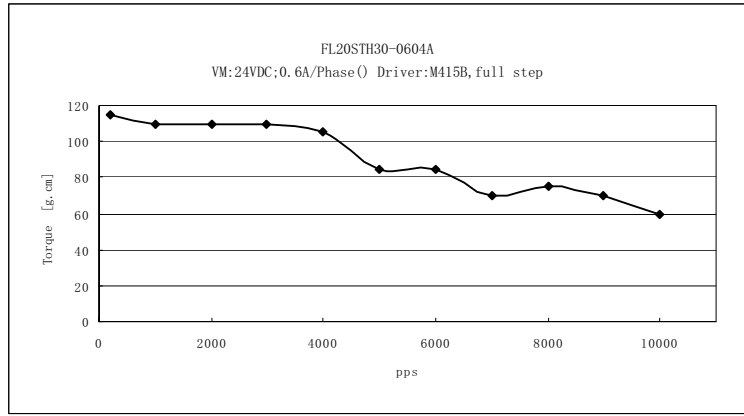

# 1.8° Size 28mm High Torque Hybrid Stepping Motor

A4



Item	Specifications
Step Angle	1.8°
Step Angle Accuracy	±5% (full step, no load)
Resistance Accuracy	±10%
Inductance Accuracy	±20%
Temperature Rise	80° C Max.(rated current,2 phase on)
Ambient Temperature	-20° C~+50° C
Insulation Resistance	100M Ω Min. ,500VDC
Dielectric Strength	500VAC for one minute
Shaft Radial Play	0.02Max. (450 g-load)
Shaft Axial Play	0.08Max. (450 g-load)
Max. radial force	28N (20mm from the flange)
Max. axial force	10N

## ● Size 28mm High Torque Hybrid Stepping Motor Specifications

Model No.		Rated Voltage	Current /Phase	Resistance /Phase	Inductance /Phase	Holding Torque	# of Leads	Rotor Inertia	Weight	Length
Single Shaft	Double Shaft	V	A	Ω	mH	g. cm		kg-m <sup>2</sup>	kg	mm
FL28STH32-0956A	FL28STH32-0956B	2.66	0.95	2.8	0.8	430	6	9x10 <sup>-7</sup>	0.11	31.5
FL28STH32-0674A	FL28STH32-0674B	3.8	0.67	5.6	3.4	600	4			
FL28STH45-0956A	FL28STH45-0956B	3.4	0.95	3.4	1.2	750	6	12x10 <sup>-7</sup>	0.14	44.5
FL28STH45-0674A	FL28STH45-0674B	4.56	0.67	6.8	4.9	950	4			
FL28STH51-0956A	FL28STH51-0956B	4.4	0.95	4.6	1.8	900	6	18x10 <sup>-7</sup>	0.2	50.5
FL28STH51-0674A	FL28STH51-0674B	6.2	0.67	9.2	7.2	1200	4			

## ● Dimension

with double shaft only

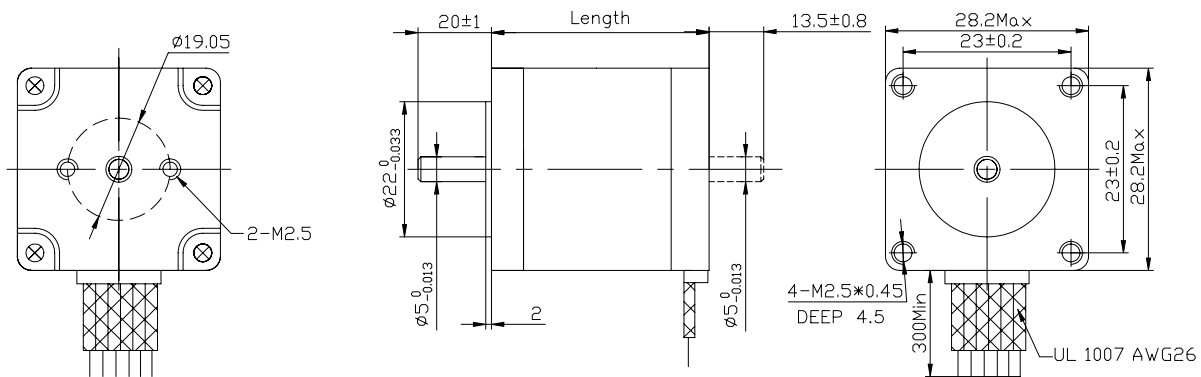

## ● Wiring Diagram:

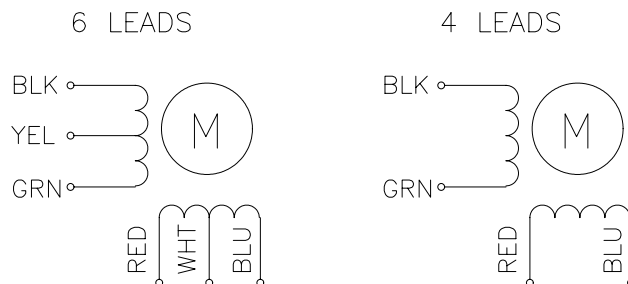

# Pull out torque:

A5

FL28STH32-0956A  
VM:24VDC;0.95A/Phase() Driver:M415B, half step

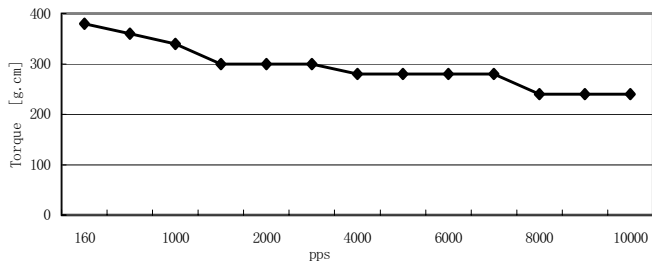

FL28STH32-0674A  
VM: 24VDC; 0.74A /Phase () Driver: M415B, half step

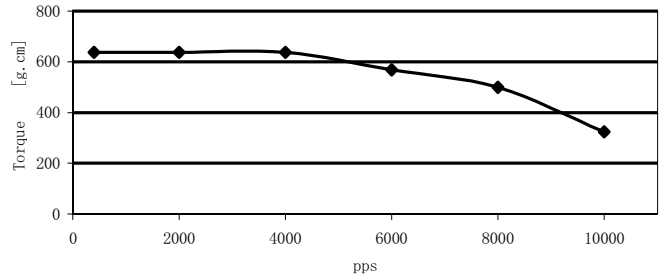

FL28STH45-0956A  
VM:24VDC;0.95A/Phase() Driver:M415B, half step

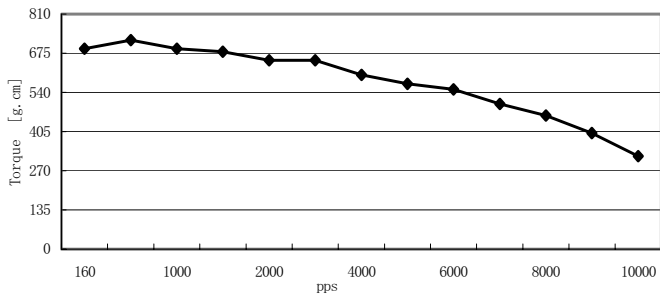

FL28STH45-0674A  
VM: 24VDC; 0.74A /Phase () Driver: M415B, half step

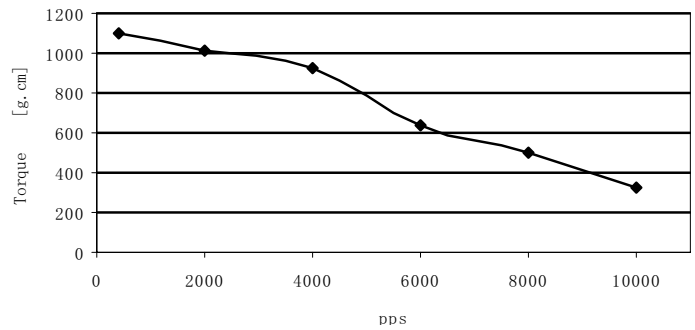

FL28STH51-0956A  
VM:24V;0.95A/Phase() Driver:M415B, half step

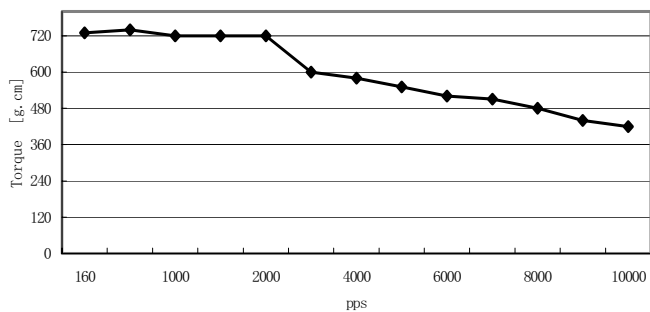

FL28STH51-0674A  
VM: 24V; 0.67A /Phase () Driver: M415B, half step

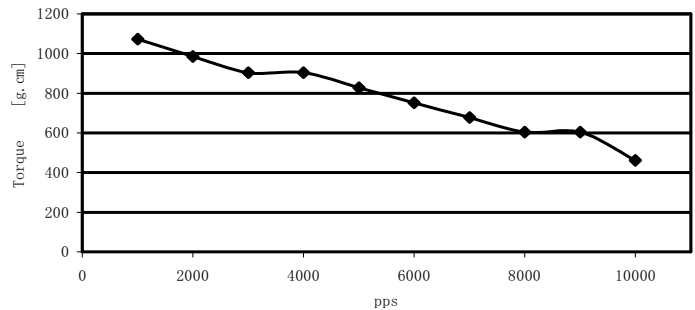

# 1.8° Size 35mm Hybrid Stepping Motor

A6

Item	Specifications
Step Angle	1.8°
Step Angle Accuracy	±5% (full step, no load)
Resistance Accuracy	±10%
Inductance Accuracy	±20%
Temperature Rise	80° C Max.(rated current,2 phase on)
Ambient Temperature	-20° C~+50° C
Insulation Resistance	100M Ω Min. ,500VDC
Dielectric Strength	500VAC for one minute
Shaft Radial Play	0.02Max. (450 g-load)
Shaft Axial Play	0.08Max. (450 g-load)
Max. radial force	28N (20mm from the flange)
Max. axial force	10N

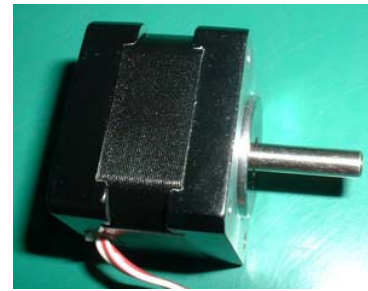

## ● Size 35mm Hybrid Stepping Motor Specifications

Model No.		Rated Voltage	Current /Phase	Resistance /Phase	Inductance /Phase	Holding Torque	# of Leads	Rotor Inertia	Weight	Detent Torque	Length
Single shaft	Double shaft	V	A	Ω	mH	g-cm	#	g-cm <sup>2</sup>	kg	g-cm	mm
FL35ST26-0284A	FL35ST26-0284B	7.4	0.28	26	27	700	4	10	0.13	60	26
FL35ST28-0504A	FL35ST28-0504B	10	0.5	20	18	1000	4	11	0.14	80	28
FL35ST36-1004A	FL35ST36-1004B	2.7	1.0	2.7	4.3	1400	4	14	0.18	100	36

## ● Dimension

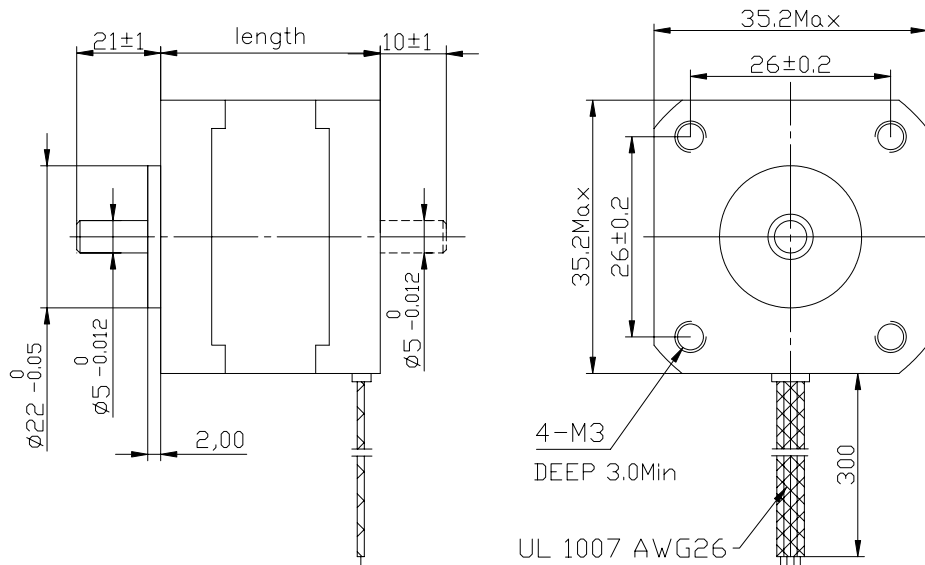

## ● Wiring Diagram

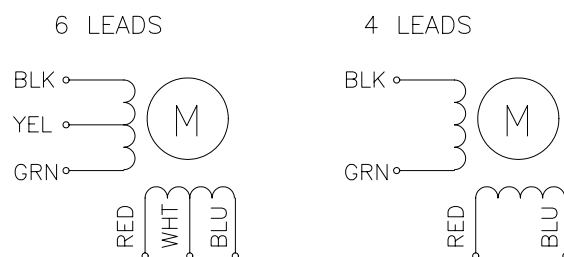

● Pull out torque curve

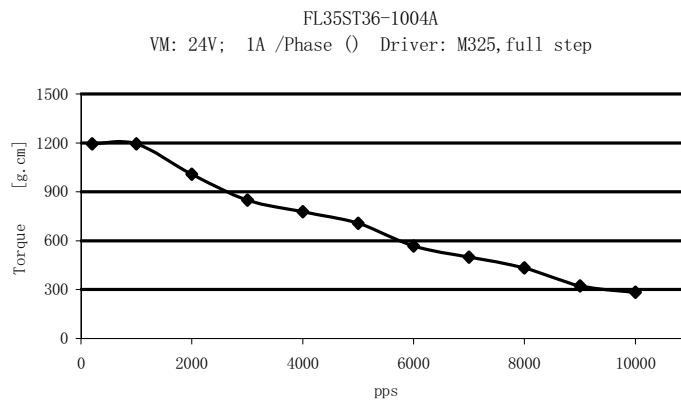
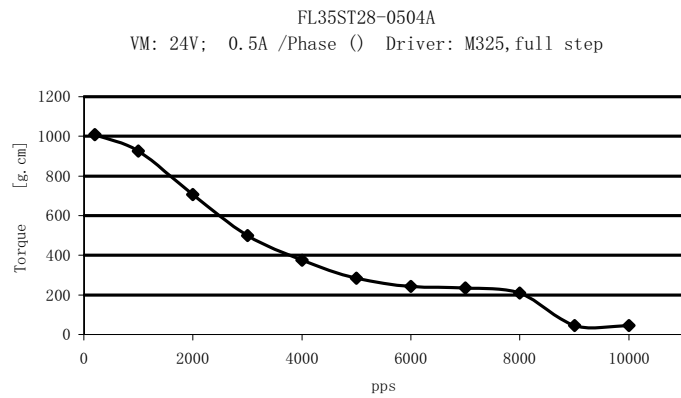
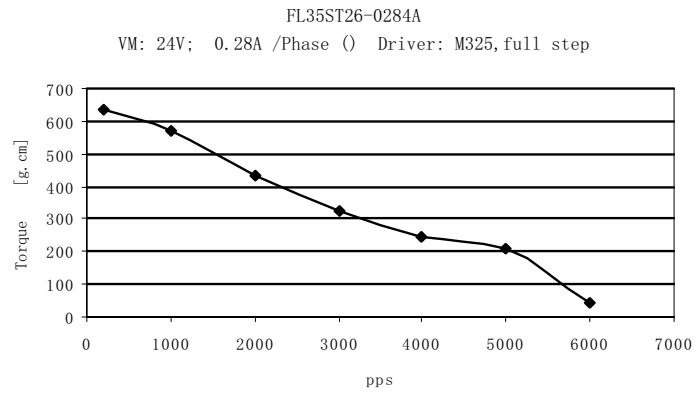

# 1.8° Size 39mm Hybrid Stepping Motor

A8

Item	Specifications
Step Angle	1.8°
Step Angle Accuracy	± 5% (full step, no load)
Resistance Accuracy	± 10%
Inductance Accuracy	± 20%
Temperature Rise	80° C Max.(rated current,2 phase on)
Ambient Temperature	-20° C~+50° C
Insulation Resistance	100M Ω Min. ,500VDC
Dielectric Strength	500VAC for one minute
Shaft Radial Play	0.02Max. (450 g-load)
Shaft Axial Play	0.08Max. (450 g-load)
Max. radial force	28N (20mm from the flange)
Max. axial force	10N

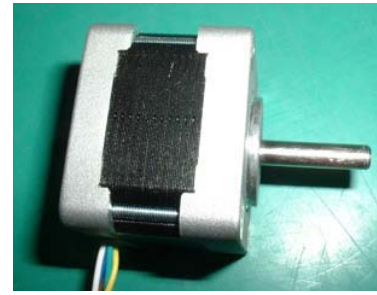

## ● Size 39mm Hybrid Stepping Motor Specifications

Model No.		Rated Voltage	Current /Phase	Resistance /Phase	Inductance /Phase	Holding Torque	# of Leads	Rotor Inertia	Weight	Detent Torque	Length
Single shaft	Double shaft	V	A	Ω	mH	g-cm		g-cm <sup>2</sup>	kg	g-cm	mm
FL39ST20-0404A	FL39ST20-0404B	2.64	0.4	6.6	7.5	650	4	11	0.12	50	20
FL39ST20-0506A	FL39ST20-0506B	6.5	0.5	13	7.5	800	6				
FL39ST34-0404A	FL39ST34-0404B	12	0.4	30	32	2100	4	20	0.18	120	34
FL39ST34-0306A	FL39ST34-0306B	12	0.3	40	20	1300	6				
FL39ST38-0504A	FL39ST38-0504B	12	0.5	24	45	2900	4	24	0.2	180	38
FL39ST38-0806A	FL39ST38-0806B	6	0.8	7.5	6	2000	6				
FL39ST44-0304A	FL39ST44-0304B	12	0.3	40	100	2800	4	40	0.25	250	44

## ● Dimension

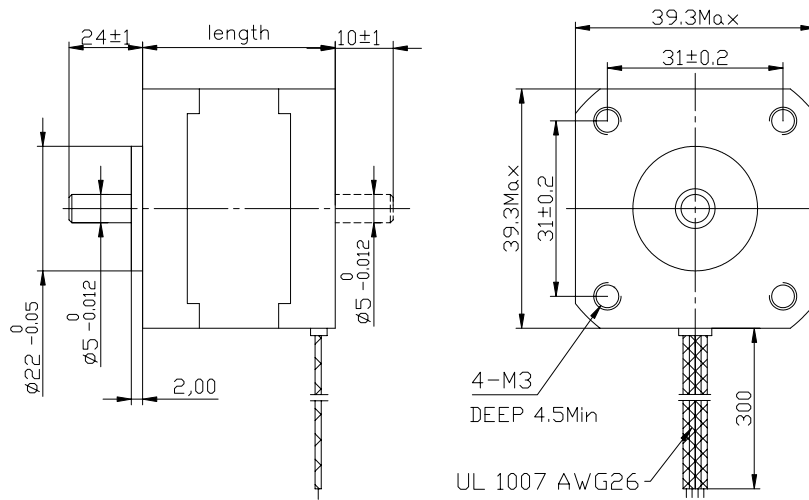

## ● Wiring Diagram

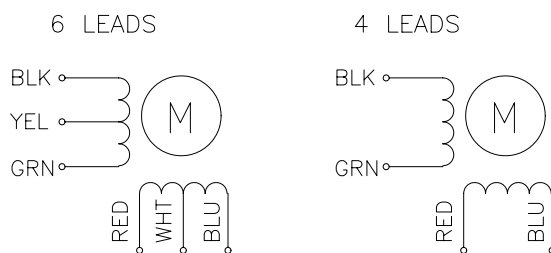

● Pull out Torque Curve

FL39ST20-0404A

VM: 24VDC; 0.445A /Phase () Driver: M415B half step

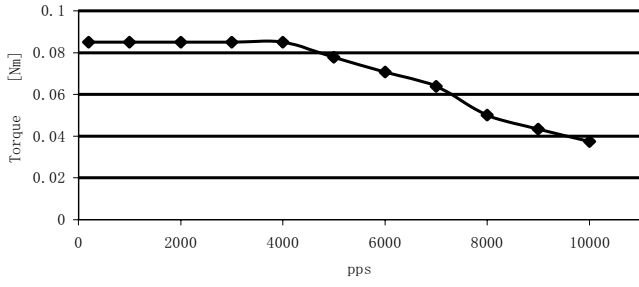

FL39ST20-0506A

VM: 24VDC; 0.5A /Phase () Driver: M325, half step

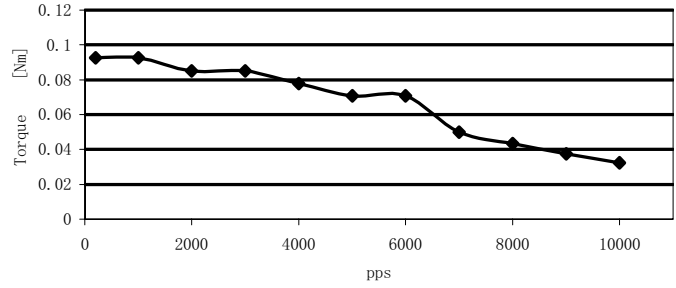

FL39ST34-0404A

VM: 24VDC; 0.445A /Phase () Driver: M415B half step

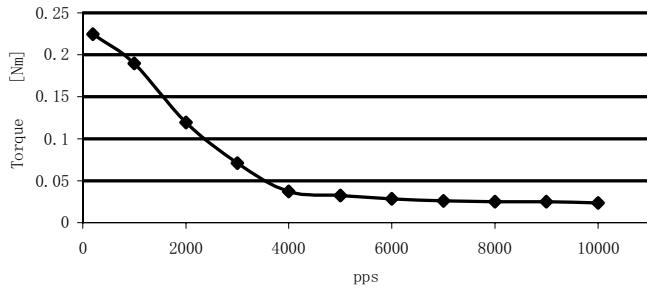

FL39ST34-0306A

VM: 24VDC; 0.226A /Phase () Driver: M415, half step

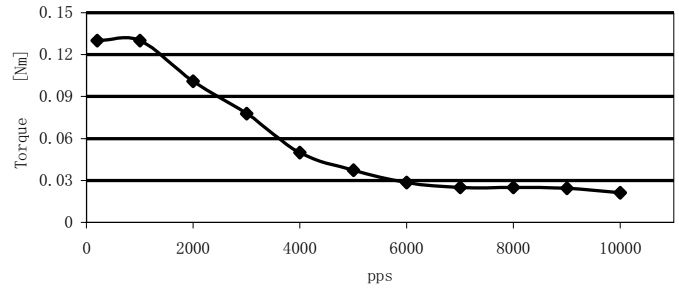

FL39ST38-0504A

VM: 24VDC; 0.502A /Phase () Driver: M325, half step

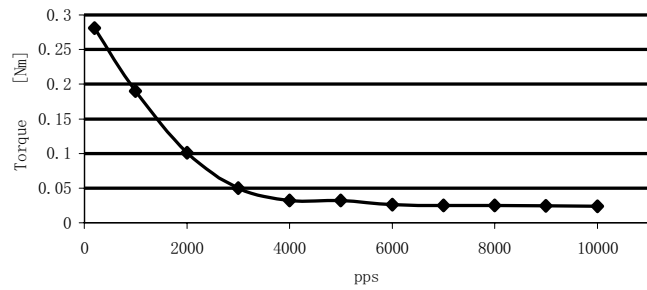

FL39ST38-0806A

VM: 24VDC; 0.78A /Phase () Driver: M415B half step

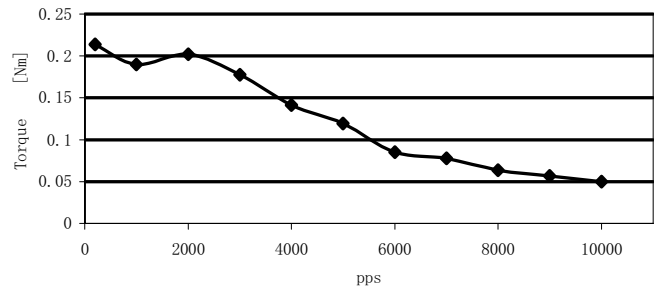

FL39ST44-0304A

VM: 24VDC; 0.226A /Phase () Driver: M415, half step

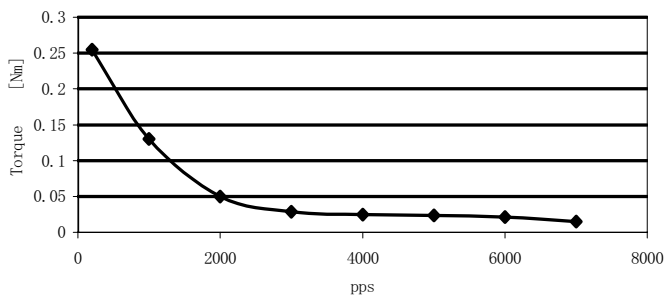



# 0.9° Size 42mm High Torque Hybrid Stepping Motor

A10

Item	Specifications
Step Angle	0.9°
Step Angle Accuracy	± 5% (full step, no load)
Resistance Accuracy	± 10%
Inductance Accuracy	± 20%
Temperature Rise	80° C Max.(rated current,2 phase on)
Ambient Temperature	-20° C~+50° C
Insulation Resistance	100M Ω Min. ,500VDC
Dielectric Strength	500VAC for one minute
Shaft Radial Play	0.02Max. (450 g-load)
Shaft Axial Play	0.08Max. (450 g-load)
Max. radial force	28N (20mm from the flange)
Max. axial force	10N



## ● Size 42mm High Torque Hybrid Stepping Motor Specifications

Model No.		Rated Voltage	Current /Phase	Resistance /Phase	Inductance /Phase	Holding Torque	# of Leads	Rotor Inertia	Weight	Detent Torque	Length
Single Shaft	Double Shaft	V	A	Ω	mH	Kg-cm		g-cm <sup>2</sup>	kg	g-cm	mm
FL42STH33-0956MA	FL42STH33-0956MB	4	0.95	4.2	4	1.58	6	35	0.22	200	33
FL42STH33-0606MA	FL42STH33-0606MB	6	0.6	10	9.5	1.58	6				
FL42STH33-0316MA	FL42STH33-0316MB	12	0.31	38.5	33	1.58	6				
FL42STH33-1334MA	FL42STH33-1334MB	2.8	1.33	2.1	4.2	2.2	4	54	0.28	220	39
FL42STH38-1206MA	FL42STH38-1206MB	4	1.2	3.3	3.4	2.59	6				
FL42STH38-0806MA	FL42STH38-0806MB	6	0.8	7.5	6.7	2.59	6				
FL42STH38-0406MA	FL42STH38-0406MB	12	0.4	30	30	2.59	6				
FL42STH38-1684MA	FL42STH38-1684MB	2.8	1.68	1.65	3.2	3.3	4	68	0.35	250	47
FL42STH47-1206MA	FL42STH47-1206MB	4	1.2	3.3	4	3.17	6				
FL42STH47-0806MA	FL42STH47-0806MB	6	0.8	7.5	10	3.17	6				
FL42STH47-0406MA	FL42STH47-0406MB	12	0.4	30	38	3.17	6				
FL42STH47-1684MA	FL42STH47-1684MB	2.8	1.68	1.65	4.1	4.4	4				

### Dimension

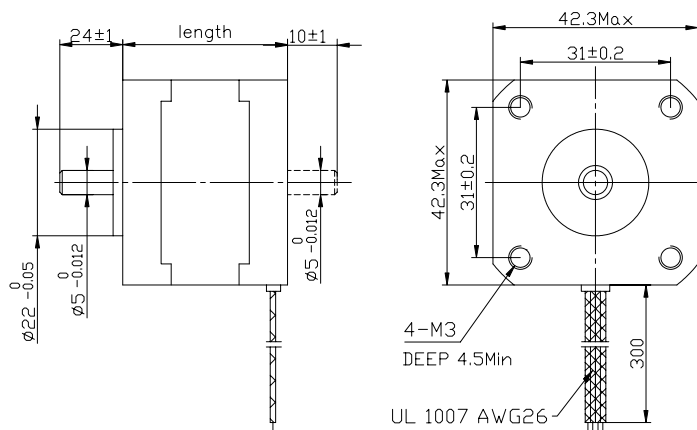

### Wiring Diagram

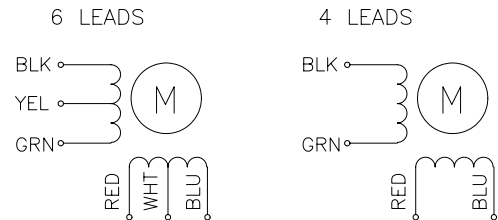

# ● Pull out Torque Curve

FL42STH33-0956MA

VM: 24VDC; 1.00A /Phase () Driver: M325, FULL step

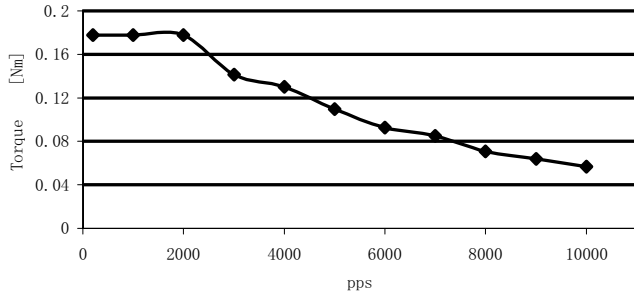

FL42STH33-0606MA

VM: 24VDC; 0.6A /Phase () Driver: M415B, full step

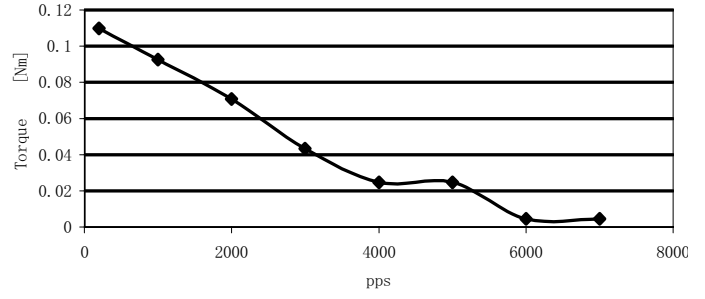

FL42STH33-0316MA

VM: 24VDC; 0.31A /Phase () Driver: M325, full step

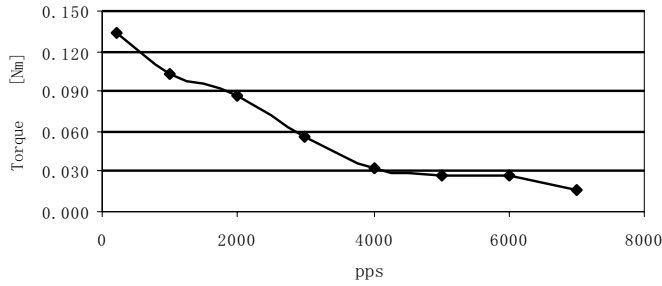

FL42STH33-1334MA

VM: 24VDC; 1.27A /Phase () Driver: HA335, full step

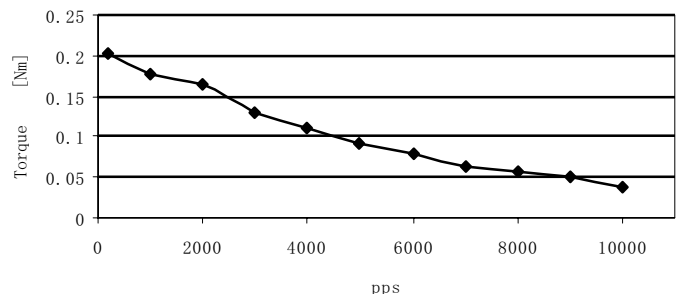

FL42STH38-1206MA

VM: 24VDC; 1.2A /Phase () Driver: HA335, full step

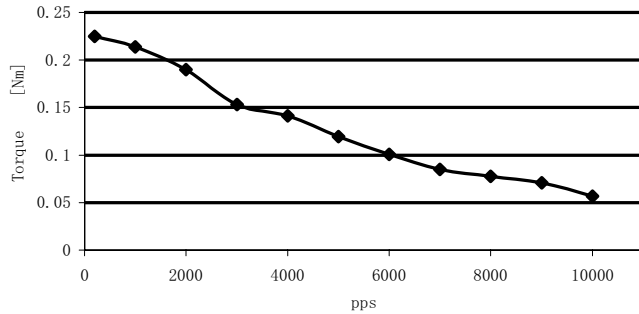

FL42STH38-0806MA

VM: 24VDC; 0.78A /Phase () Driver: M325, full step

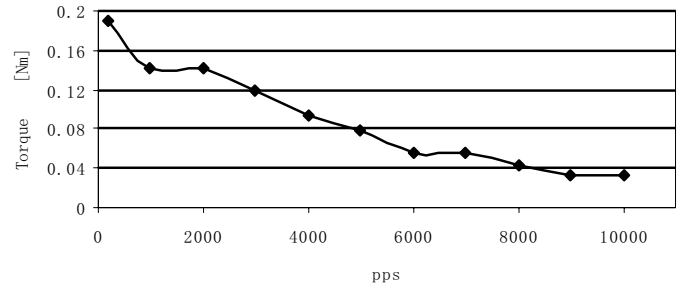

FL42STH38-0404MA

VM: 24VDC; 0.4A /Phase () Driver: M325, full step

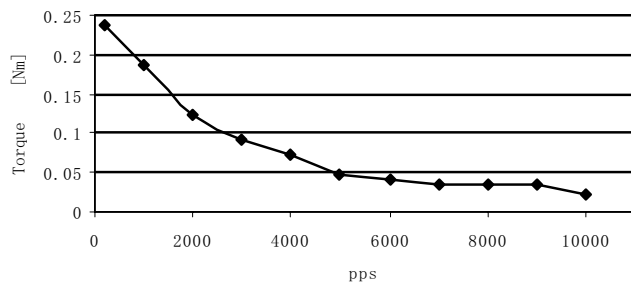

FL42STH38-1684MA

VM: 24VDC; 1.68A /Phase () Driver: HA335, full step

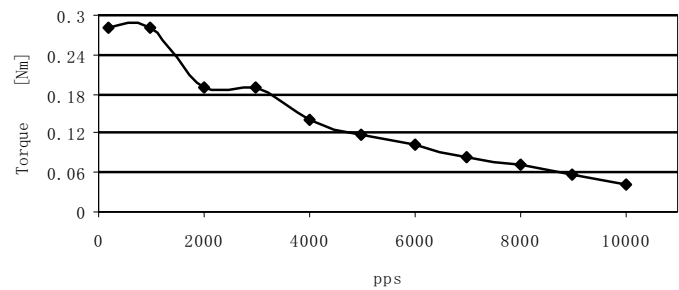

# ● Pull out Torque Curve

FL42STH47-1206MA

VM: 24VDC; 1.2A /Phase () Driver: HA335, full step

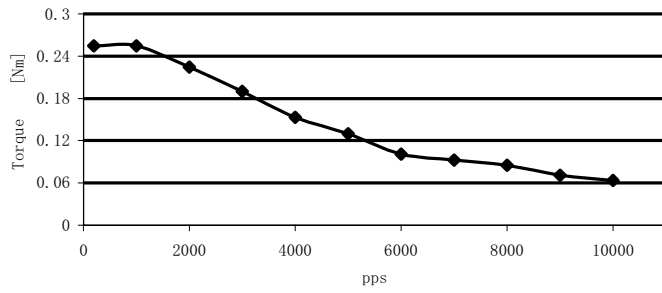

FL42STH47-0806MA

VM: 24V; 0.84A /Phase () Driver: HA335, full step

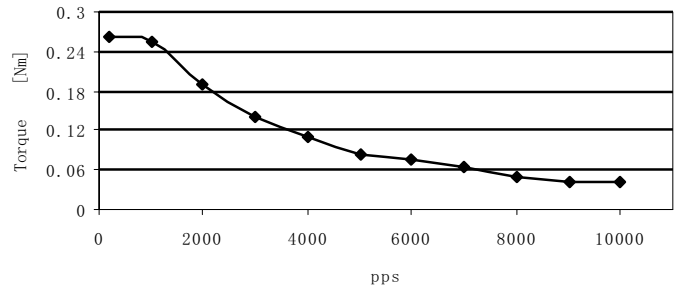

FL42STH47-0406MA

VM: 24VDC; 0.4A /Phase () Driver: M325, full step

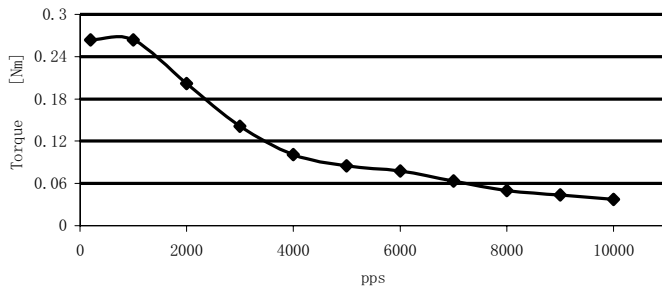

FL42STH47-1684MA

VM: 30VDC; 1.77A /Phase () Driver: HA335, full step

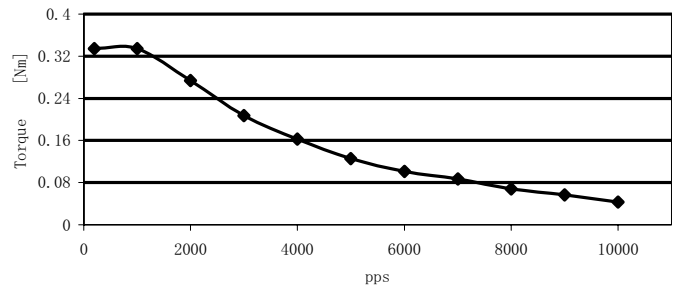

# 1.8° Size 42mm High Torque Hybrid Stepping Motor

A13

Item	Specifications
Step Angle	1.8°
Step Angle Accuracy	± 5% (full step, no load)
Resistance Accuracy	± 10%
Inductance Accuracy	± 20%
Temperature Rise	80° C Max.(rated current,2 phase on)
Ambient Temperature	-20° C~+50° C
Insulation Resistance	100M Ω Min. ,500VDC
Dielectric Strength	500VAC for one minute
Shaft Radial Play	0.02Max. (450 g-load)
Shaft Axial Play	0.08Max. (450 g-load)
Max. radial force	28N (20mm from the flange)
Max. axial force	10N



## ● Size 42mm High Torque Hybrid Stepping Motor Specifications

Model No.		Rated Voltage	Current /Phase	Resistance /Phase	Inductance /Phase	Holding Torque	# of Leads	Rotor Inertia	Weight	Detent Torque	Length
Single Shaft	Double Shaft	V	A	Ω	mH	Kg-cm		g-cm <sup>2</sup>	kg	g-cm	mm
FL42STH25-0404A	FL42STH25-0404B	9.6	0.4	24	36	1.7	4	20	0.15	75	25
FL42STH33-0956A	FL42STH33-0956B	4	0.95	4.2	2.5	1.6	6	35	0.22	120	34
FL42STH33-0406A	FL42STH33-0406B	9.6	0.4	24	15	1.6	6				
FL42STH33-0316A	FL42STH33-0316B	12	0.31	38.5	21	1.6	6				
FL42STH33-1334A	FL42STH33-1334B	2.8	1.33	2.1	2.5	2.2	4	54	0.28	150	40
FL42STH38-1206A	FL42STH38-1206B	4	1.2	3.3	3.2	2.6	6				
FL42STH38-0806A	FL42STH38-0806B	6	0.8	7.5	6.7	2.6	6				
FL42STH38-0406A	FL42STH38-0406B	12	0.4	30	30	2.6	6				
FL42STH38-1684A	FL42STH38-1684B	2.8	1.68	1.65	3.2	3.6	4	68	0.35	200	48
FL42STH47-1206A	FL42STH47-1206B	4	1.2	3.3	2.8	3.17	6				
FL42STH47-0806A	FL42STH47-0806B	6	0.8	7.5	6.3	3.17	6				
FL42STH47-0406A	FL42STH47-0406B	12	0.4	30	25	3.17	6				
FL42STH47-1684A	FL42STH47-1684B	2.8	1.68	1.65	2.8	4.4	4	102	0.5	280	60
FL42STH60-1206A	FL42STH60-1206B	7.2	1.2	6	7	6.5	6				

### Dimension

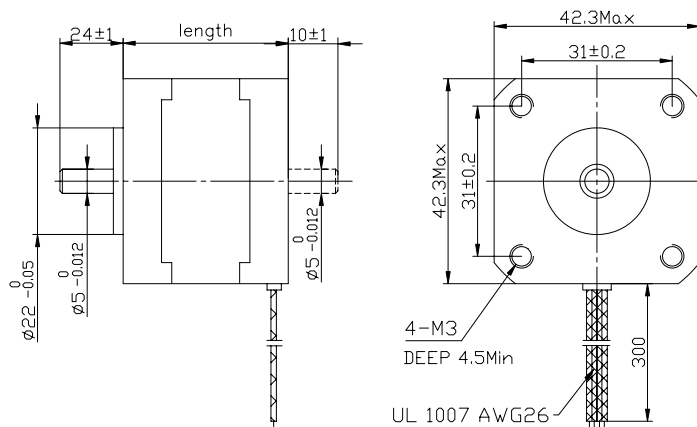

### Wiring Diagram

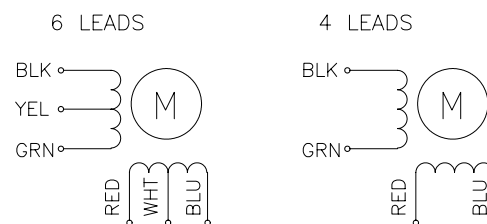

# ● Pull out Torque Curve

FL42STH33-0956A

VM: 24VDC; 1A /Phase () Driver: HA335, half step

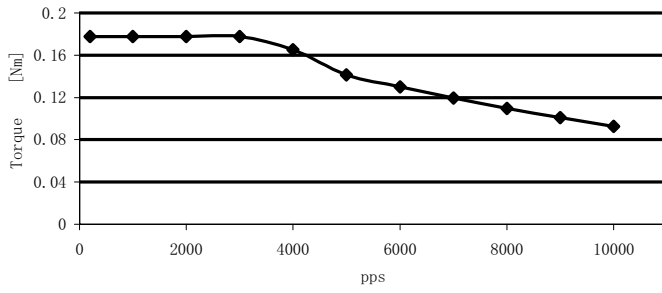

FL42STH33-0406A

VM: 24VDC; 0.5A /Phase () Driver: HA335, half step

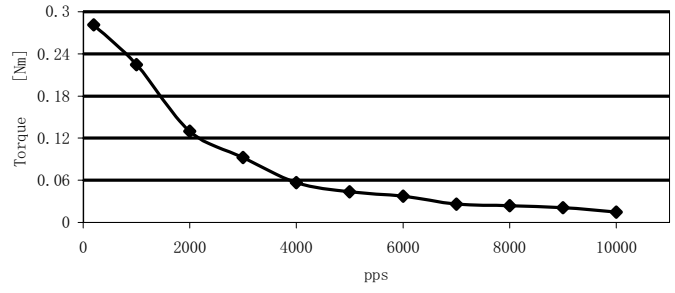

FL42STH33-0316A

VM: 24VDC; 0.3A /Phase () Driver: M415B, half step

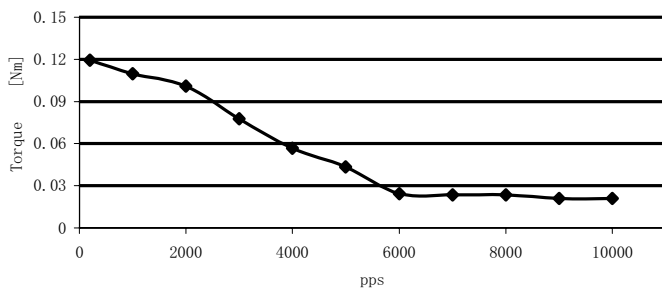

FL42STH33-1334A

VM: 24VDC; 1.27A /Phase () Driver: HA335, half step

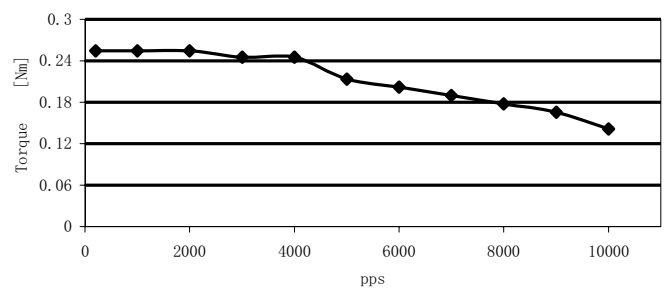

FL42STH38-1206A

VM: 24VDC; 1.2A /Phase () Driver: HA335, half step

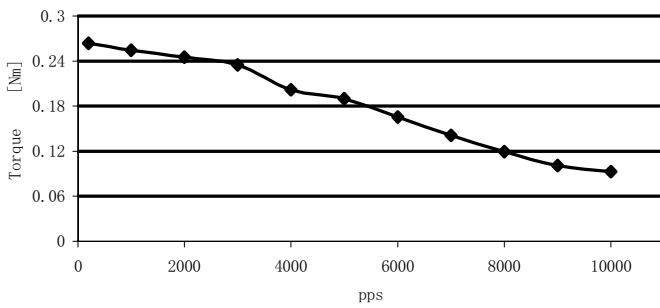

FL42STH38-0806A

VM: 24VDC; 0.8A /Phase () Driver: M325, half step

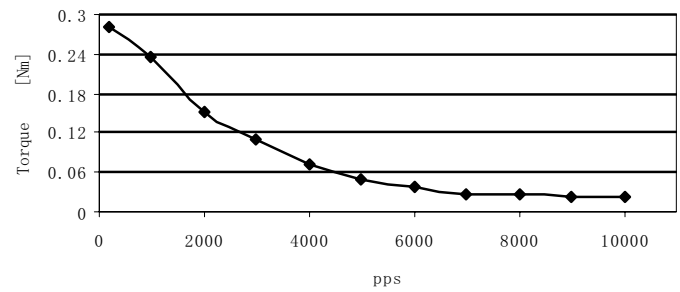

FL42STH38-0406A

VM: 24VDC; 0.5A /Phase () Driver: HA335, half step

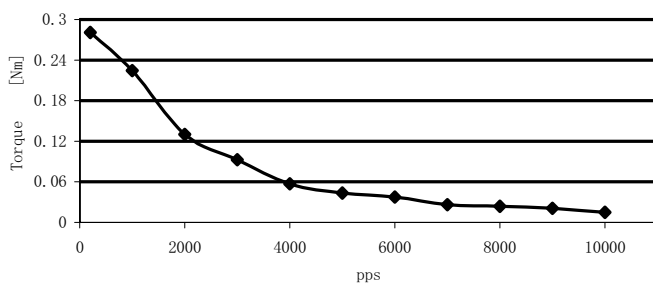

FL42STH38-1684A

VM: 24VDC; 1.77A /Phase () Driver: HA335, half step

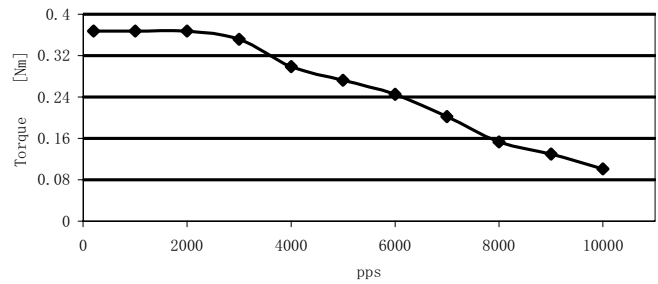

FL42STH47-1206A

VM: 24VDC; 1.2A /Phase () Driver: HA335, half step

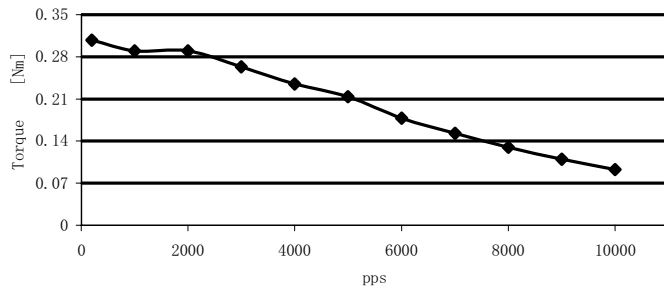

FL42STH47-0806A

VM: 24VDC; 0.8A /Phase () Driver: M325, half step

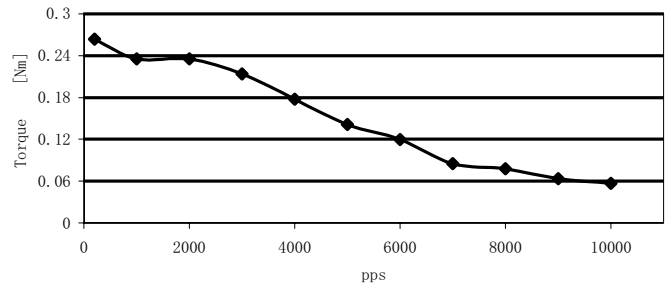

FL42STH47-0406A

VM: 24VDC; 0.44A /Phase () Driver: M415B, half step

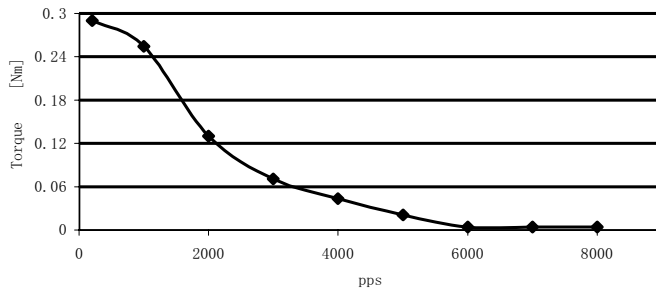

FL42STH47-1684A

VM: 24VDC; 1.77A /Phase () Driver: HA335, half step

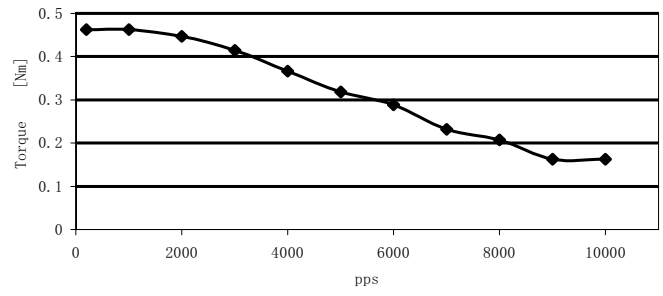

# 1.8° Size 42mm High Torque Hybrid Stepping Motor With Thread A15

## ● General Specification for High Torque Hybrid Stepping Motor With Thread

Item	Specifications
Step Angle	1.8°
Step Angle Accuracy	±5% (full step, no load)
Resistance Accuracy	±10%
Inductance Accuracy	±20%
Temperature Rise	80° C Max.(rated current,2 phase on)
Ambient Temperature	-20° C~+50° C
Insulation Resistance	100M Ω Min. ,500VDC
Dielectric Strength	500VAC for one minute
Max. radial force	28N (20mm from the flange)
Max. axial force	10N

## ● Size 42mm High Torque Hybrid Stepping Motor Specifications With Thread

Model No.	Rated Voltage	Current /Phase	Resistance /Phase	Inductance /Phase	Holding Torque	# of Leads	Rotor Inertia	Weight	Detent Torque	Length
Single Shaft	V	A	Ω	mH	g-cm		g-cm <sup>2</sup>	kg	g-cm	mm
FL42STH33T-0554A	1.8	0.55	3.2	4.5	900	4	35	0.2	120	34
FL42STH33S-0956A	4.0	0.95	4.2	2.5	1580	6	35	0.2	120	34

## Dimension

FL42STH33T-0554A

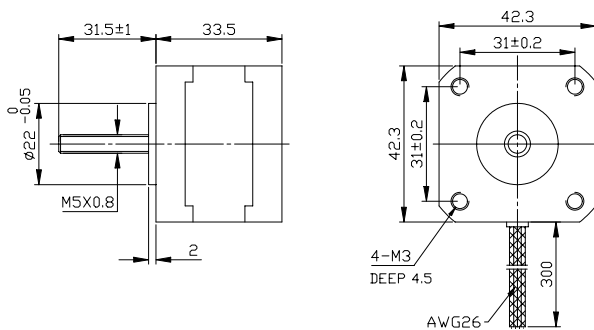

FL42STH33S-0956A

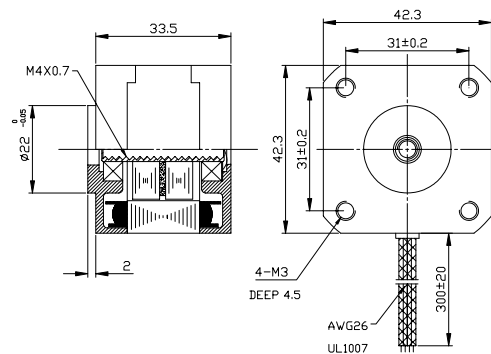

## ● Wiring Diagram

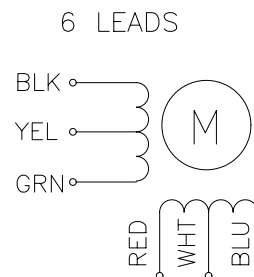
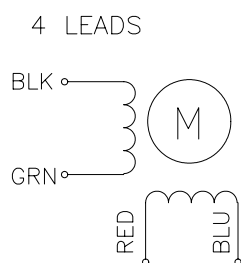

# 3.6° Size 42mm Hybrid Stepping Motor

A16

## ● General Specification for High Torque Hybrid Stepping Motor

Item	Specifications
Step Angle	3.6°
Step Angle Accuracy	±5% (full step, no load)
Resistance Accuracy	±10%
Inductance Accuracy	±20%
Temperature Rise	80° C Max.(rated current,2 phase on)
Ambient Temperature	-20° C~+50° C
Insulation Resistance	100M Ω Min. ,500VDC
Dielectric Strength	500VAC for one minute
Shaft Radial Play	0.02Max. (450 g-load)
Shaft Axial Play	0.08Max. (450 g-load)
Max. radial force	28N (20mm from the flange)
Max. axial force	10N



## ● Size 42mm Hybrid Stepping Motor Specifications

Model No.		Rated Voltage	Current /Phase	Resistance /Phase	Inductance /Phase	Holding Torque	# of Leads	Rotor Inertia	Weight	Detent Torque	Length
Single Shaft	Double Shaft	V	A	Ω	mH	g-cm		g-cm <sup>2</sup>	kg	g-cm	mm
FL42ST33-0114DA	FL42ST33-0114DB	14	0.114	123	130	780	4	20	0.2	150	34
FL42ST33-0156DA	FL42ST33-0156DB	15	0.15	100	60	500	6	20	0.2	150	34
FL42ST33-0954DA	FL42ST33-0954DB	9.31	0.095	98	200	530	4	20	0.20	150	34
FL42ST38-0954DA	FL42ST38-0954DB	9.98	0.095	105	330	700	4	23	0.23	150	38

## ● Dimension

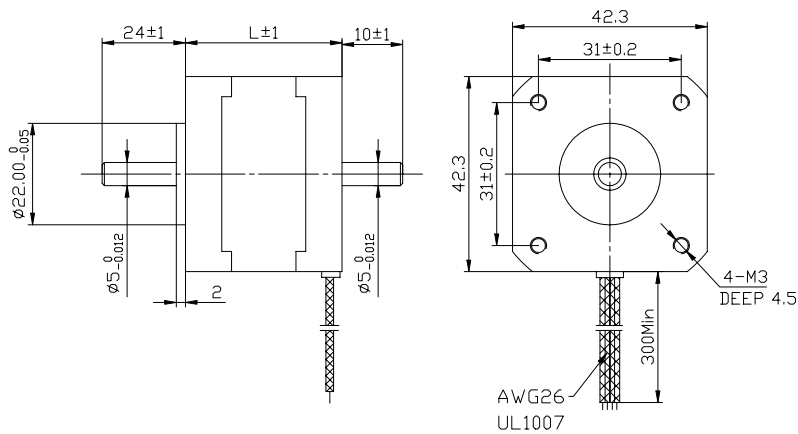

## ● Wiring Diagram:

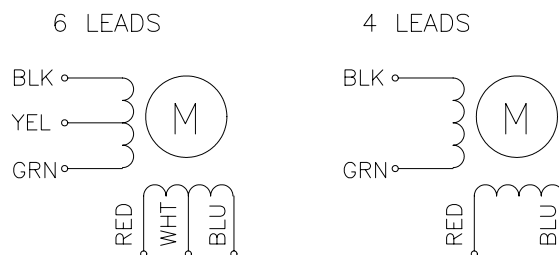



● Pull out Torque Curve:

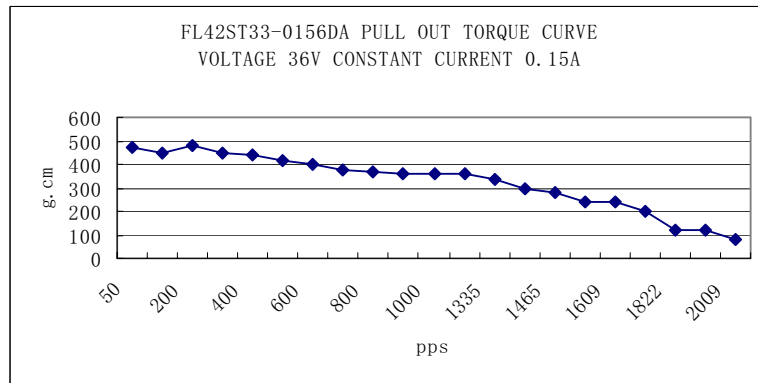

FL42STH33-0114DA PULL OUT TORQUE CURVE  
VOLTAGE: 18VDC, CURRENT: 0.114A, FULL STEP

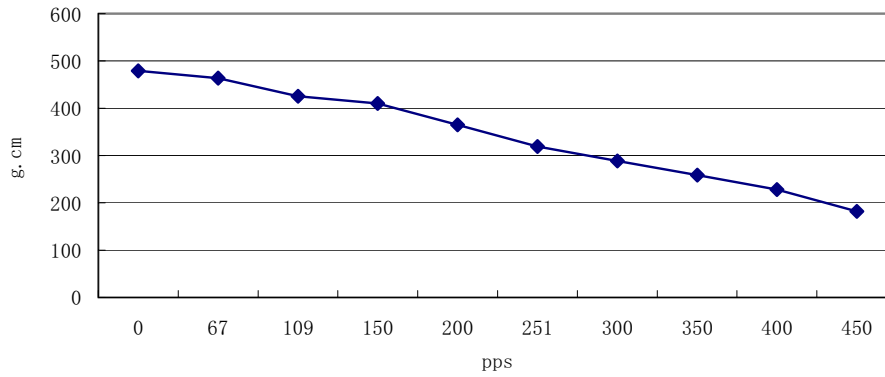

FL42ST33-0954DA PULL OUT TORQUE CURVE  
VOLTAGE: 18VDC, CURRENT: 0.095A, HALF STEP

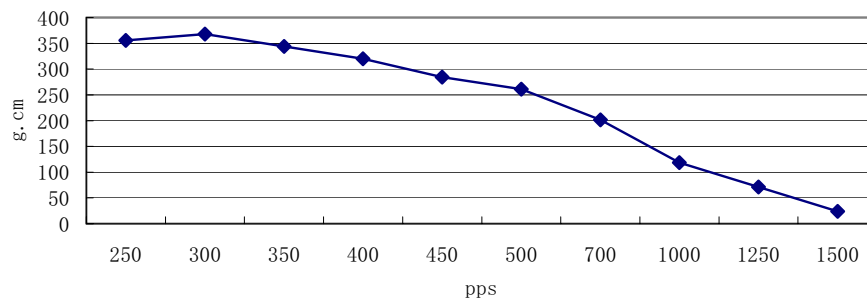

FL42ST38-0954DA PULL OUT TORQUE CURVE  
VOLTAGE: 18VDC, CURRENT: 0.095A, HALF STEP

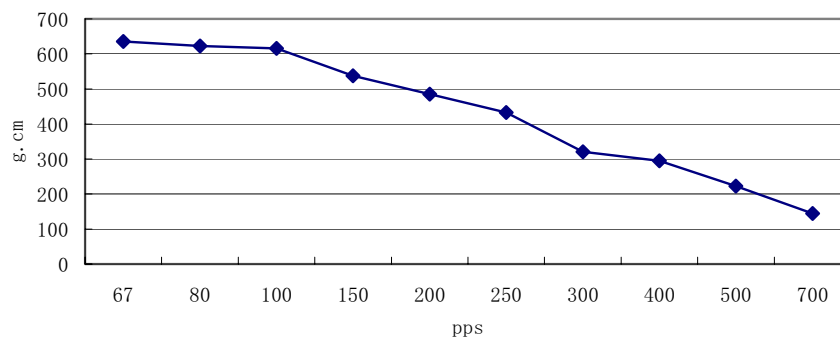

# 0.9° Size 57mm High torque Hybrid Stepping Motors

A18

Item	Specifications
Step Angle	0.9°
Step Angle Accuracy	± 5% (full step, no load)
Resistance Accuracy	± 10%
Inductance Accuracy	± 20%
Temperature Rise	80° C Max.(rated current,2 phase on)
Ambient Temperature	-20° C~+50° C
Insulation Resistance	100M Ω Min. ,500VDC
Dielectric Strength	500VAC for one minute
Shaft Radial Play	0.02Max. (450 g-load)
Shaft Axial Play	0.08Max. (450 g-load)
Max. radial force	75N (20mm from the flange)
Max. axial force	15N



## ● Size 57mm High Torque Hybrid Stepping Motor Specifications

Model No.		Rated Voltage	Current /Phase	Resistance /Phase	Inductance /Phase	Holding Torque	# of Leads	Rotor Inertia	Weight	Detent Torque	Length
Single Shaft	Double Shaft	V	A	Ω	mH	kg-cm		g-cm <sup>2</sup>	kg	kg-cm	mm
FL57STH41-1006MA	FL57STH41-1006MB	5.7	1	5.7	8.0	3.9	6	120	0.45	0.21	41
FL57STH41-2006MA	FL57STH41-2006MB	2.8	2	1.4	2.2	3.9	6				
FL57STH41-3006MA	FL57STH41-3006MB	1.9	3	0.63	1.0	3.9	6				
FL57STH41-2804MA	FL57STH41-2804MB	2	2.8	0.7	2.2	5.5	4				
FL57STH56-1006MA	FL57STH56-1006MB	7.4	1	7.4	17.5	9.0	6	300	0.7	0.4	56
FL57STH56-2006MA	FL57STH56-2006MB	3.6	2	1.8	4.5	9.0	6				
FL57STH56-3006MA	FL57STH56-3006MB	2.3	3	0.75	1.9	9.0	6				
FL57STH56-2804MA	FL57STH56-2804MB	2.5	2.8	0.9	4.5	12.0	4				
FL57STH76-1006MA	FL57STH76-1006MB	8.6	1	8.6	23	13.5	6	480	1	0.68	76
FL57STH76-2006MA	FL57STH76-2006MB	4.5	2	2.25	5.6	13.5	6				
FL57STH76-3006MA	FL57STH76-3006MB	3	3	1	2.6	13.5	6				
FL57STH76-2804MA	FL57STH76-2804MB	3.2	2.8	1.13	5.6	18.0	4				

## ● Dimension

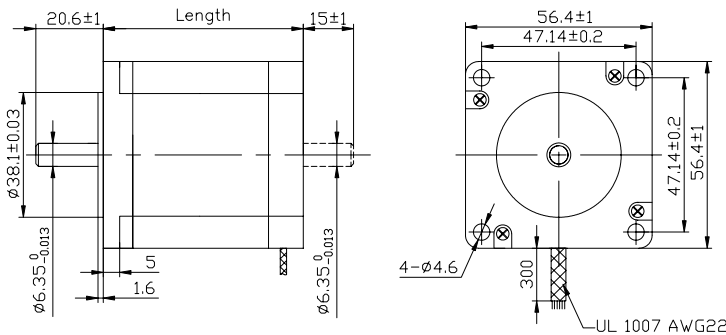

## Wiring Diagram

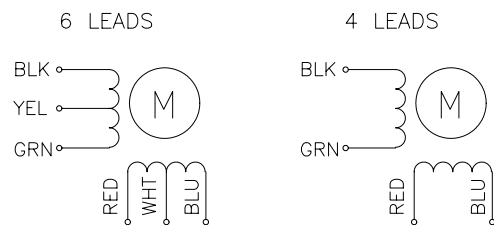

# ● Pull out Torque Curve

FL57STH41-1006MA

VM: 30VDC; 1A /Phase () Driver: HA335, full step

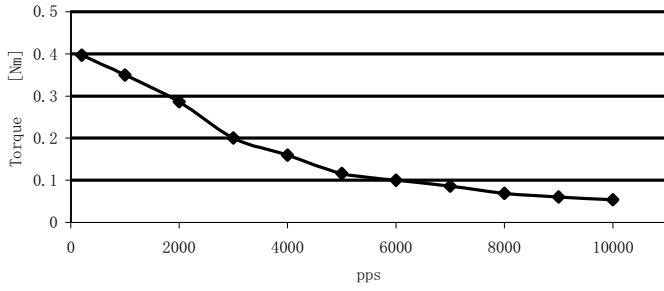

FL57STH41-2006MA

VM: 30V; 2A /Phase () Driver: M542, full step

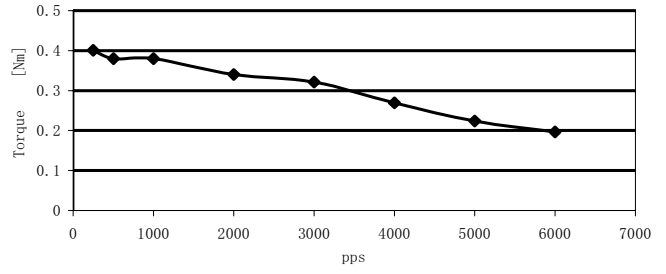

FL57STH41-3006MA

VM: 30VDC; 2.7A /Phase () Driver: H860B, full step

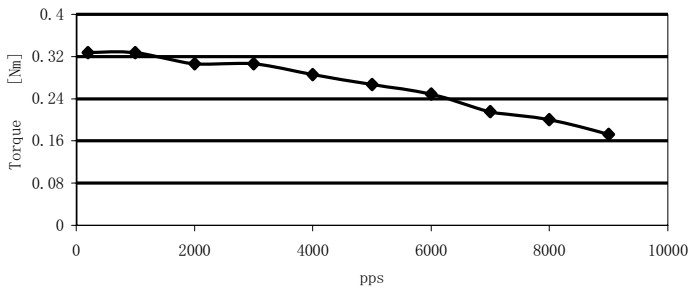

FL57STH41-2804MA

VM: 30VDC; 2.7A /Phase () Driver: H860B, full step

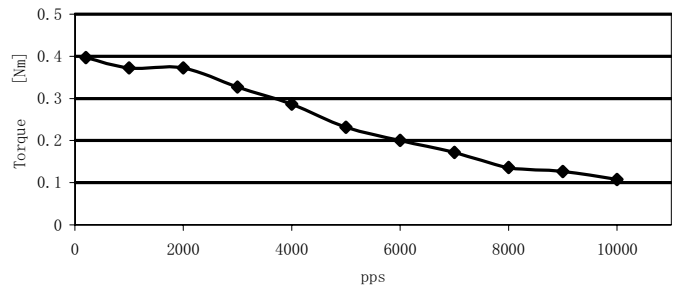

FL57STH56-1006MA

VM: 30VDC; 1A /Phase () Driver: HA335, full step

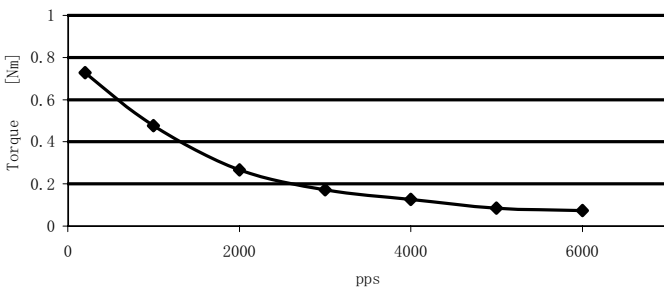

FL57STH56-2006MA

VM: 30VDC; 2.1A /Phase () Driver: HA335, full step

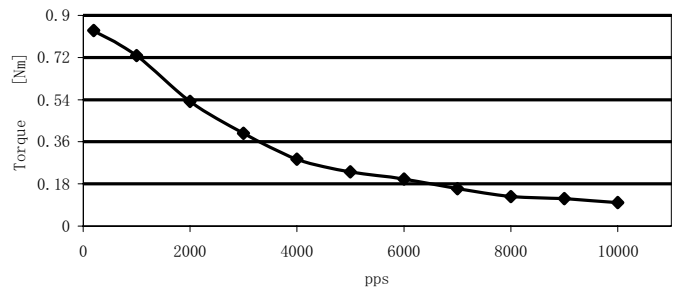

FL57STH56-3006MA

VM: 30VDC; 3A /Phase () Driver: M542, half step

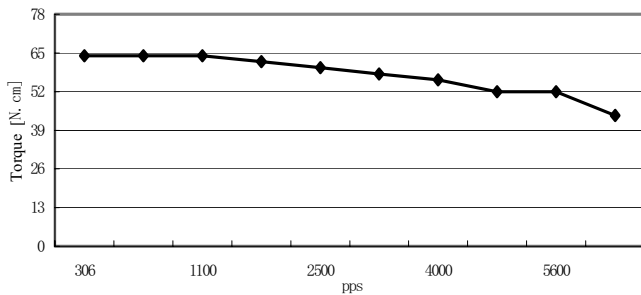

FL57STH56-2804MA

VM: 30VDC; 2.7A /Phase () Driver: H860B, full step

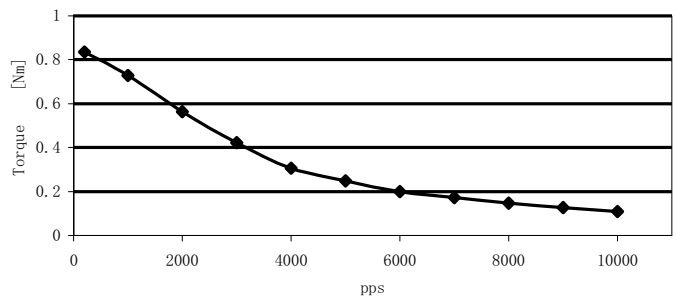

# ● Pull out Torque Curve

A20

FL57STH76-1006MA

VM: 30VDC; 1A /Phase () Driver: M542, half step

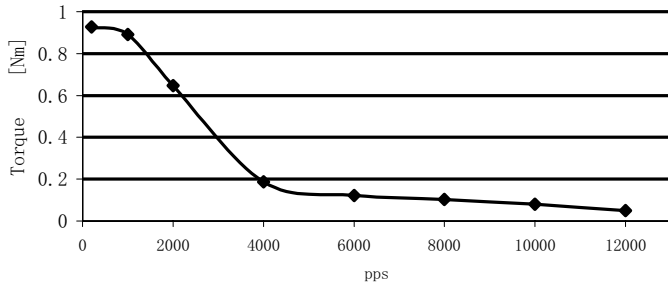

FL57STH76-2006MA

VM: 30VDC; 2.1A /Phase () Driver: HA335, full step

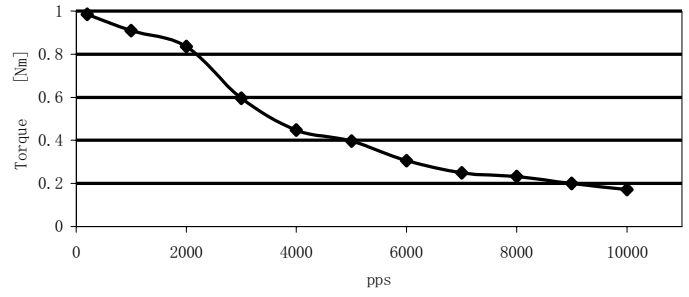

FL57STH76-3006MA

VM: 30VDC; 2.7A /Phase () Driver: H860B, full step

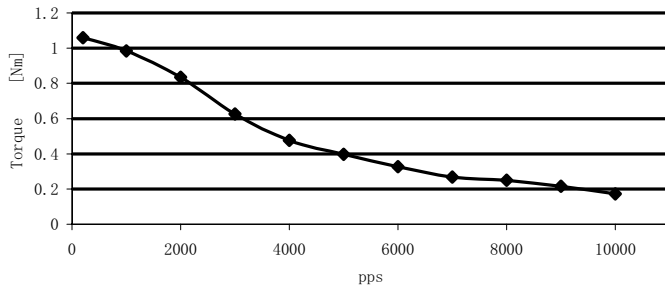

FL57STH76-2804MA

VM: 30VDC; 2.5A /Phase () Driver: HA335, full step

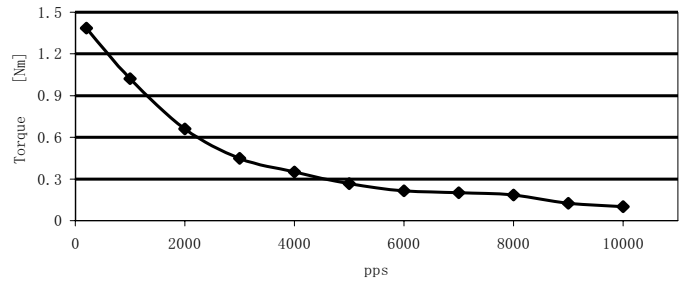

# 1.8° Size 57mm Hybrid Stepping Motor

A21

Item	Specifications
Step Angle	1.8°
Step Angle Accuracy	± 5% (full step, no load)
Resistance Accuracy	± 10%
Inductance Accuracy	± 20%
Temperature Rise	80° C Max.(rated current,2 phase on)
Ambient Temperature	-20° C~+50° C
Insulation Resistance	100M Ω Min. ,500VDC
Dielectric Strength	500VAC for one minute
Shaft Radial Play	0.02Max. (450 g-load)
Shaft Axial Play	0.08Max. (450 g-load)
Max. radial force	75N (20mm from the flange)
Max. axial force	15N



## ● Size 57mm Hybrid Stepping Motor Specifications

Model No.		Rated Voltage	Current /Phase	Resistance /Phase	Inductance /Phase	Holding Torque	# of Leads	Rotor Inertia	Weight	Detent Torque	Length
Single Shaft	Double Shaft	V	A	Ω	mH	kg-cm		g-cm <sup>2</sup>	kg	kg-cm	mm
FL57ST41-1106A	FL57ST41-1106B	4	1.1	3.6	3.6	2.88	6	57	0.54	0.18	41
FL57ST41-0406A	FL57ST41-0406B	12	0.4	30	30	2.88	6				
FL57ST41-1564A	FL57ST41-1564B	2.8	1.56	1.8	3.6	4.0	4				
FL57ST51-0856A	FL57ST51-0856B	6	0.85	7.1	9	4.97	6	110	0.60	0.35	51
FL57ST51-0426A	FL57ST51-0426B	12	0.42	29	36	4.97	6				
FL57ST51-2804A	FL57ST51-2804B	2.38	2.8	0.85	2.1	6.9	4				
FL57ST56-1206A	FL57ST56-1206B	6	1.2	5	8	6.05	6	135	0.65	0.42	56
FL57ST56-0606A	FL57ST56-0606B	12	0.6	20	32	6.05	6				
FL57ST56-2554A	FL57ST56-2554B	2.8	2.55	1.1	3.6	8.4	4				
FL57ST76-1506A	FL57ST76-1506B	5.4	1.5	3.6	6	9	6	200	0.95	0.72	76
FL57ST76-0686A	FL57ST76-0686B	12	0.68	17.7	30	9	6				
FL57ST76-3304A	FL57ST76-3304B	2.7	3.3	0.85	3	12.5	4				

## Dimension

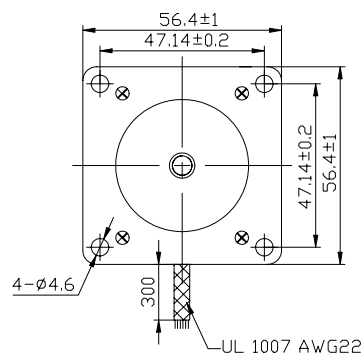
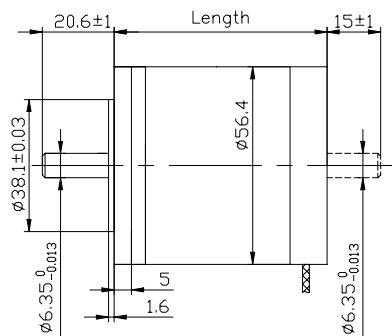

## Wiring Diagram

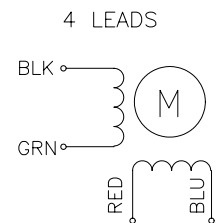
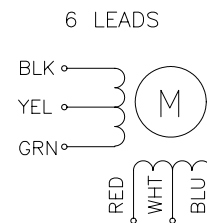

● Pull out Torque Curve

FL57ST41-1106A

VM: 30VDC; 1.1 /Phase () Driver: HA335 half step

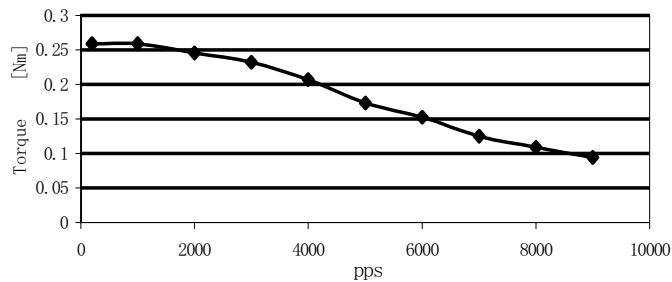

FL57ST41-0406A

VM: 30VDC; 0.4A /Phase () Driver: HA335 half step

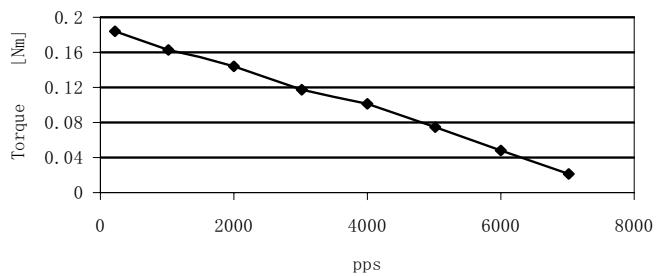

FL57ST41-1564A

VM: 30VDC; 1.4A /Phase () Driver: HA335 half step

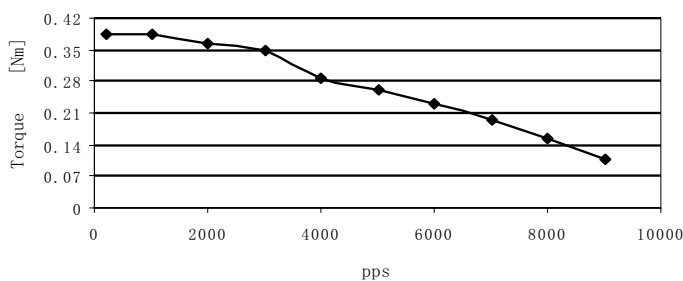

FL57ST51-0856A

VM: 30VDC; 0.85A /Phase () Driver: HA335 half step

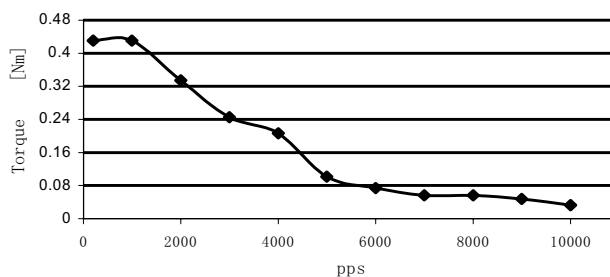

FL57ST51-0426A

VM: 30VDC; 0.5A /Phase () Driver: HA335 half step

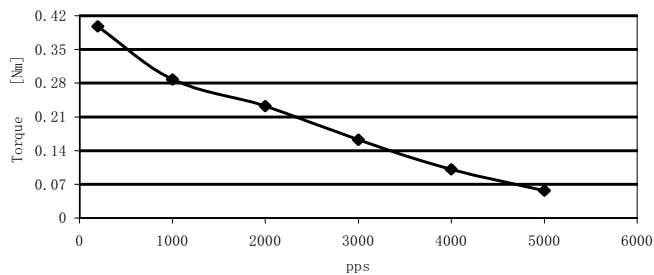

FL57STH76-1506A

VM: 30VDC; 1.4A /Phase () Driver: HA335 half step

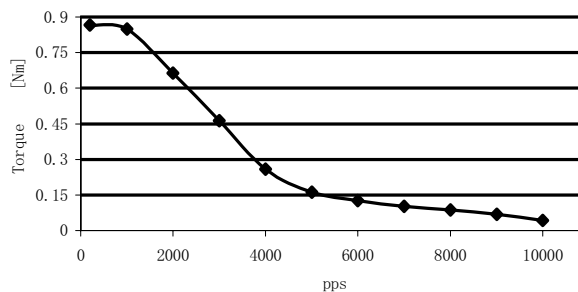

FL57ST56-1206A

VM: 30VDC; 1.2A /Phase () Driver: HA335 half step

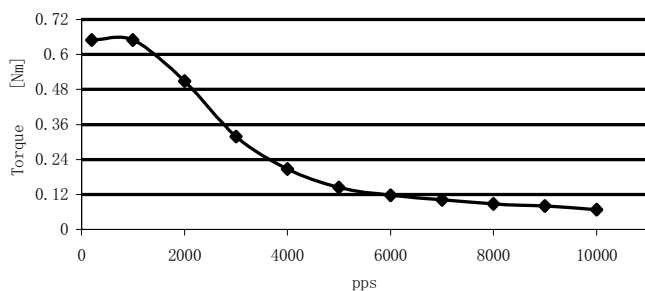

FL57STH56-0606A

VM: 30VDC; 0.5 /Phase () Driver: HA335 half step

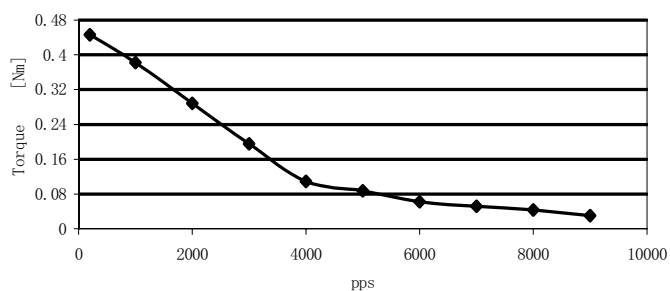

● Pull out Torque Curve

FL57ST56-2554A

VM: 30VDC; 2.5A /Phase () Driver: HA335 half step

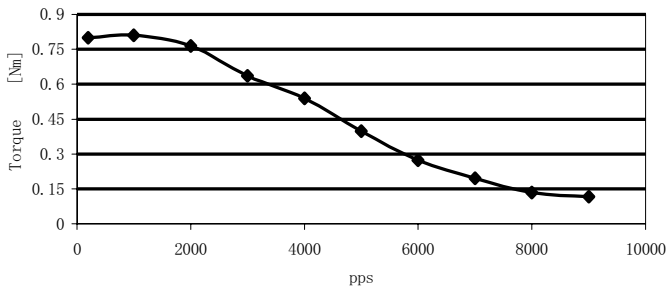

FL57STH76-1506A

VM: 30VDC; 1.4A /Phase () Driver: HA335 half step

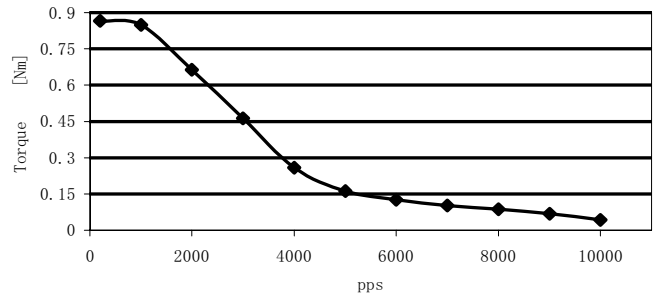

FL57ST76-0686A

VM: 30VDC; 0.7A /Phase () Driver: HA335 half step

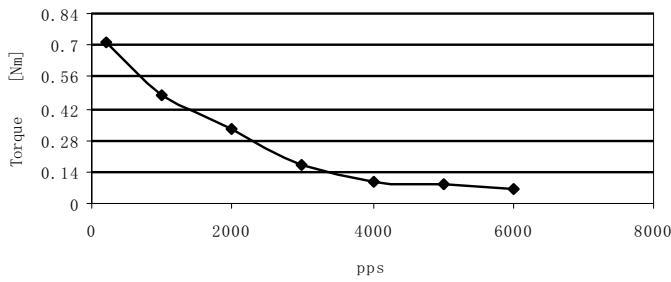

FL57ST76-3304A

VM: 30VDC; 3.04A /Phase () Driver: MD556 half step

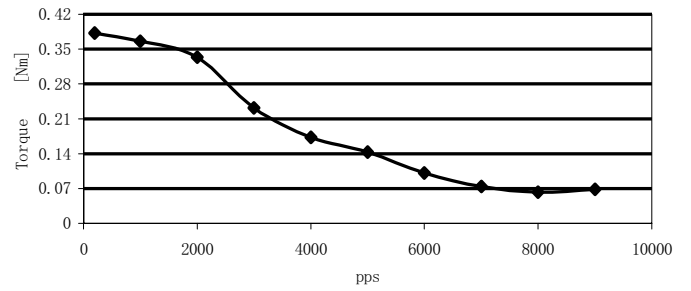

# 1.8° Size 57mm High Torque Hybrid Stepping Motor

A24

Item	Specifications
Step Angle	1.8°
Step Angle Accuracy	± 5% (full step, no load)
Resistance Accuracy	± 10%
Inductance Accuracy	± 20%
Temperature Rise	80° C Max.(rated current,2 phase on)
Ambient Temperature	-20° C~+50° C
Insulation Resistance	100M Ω Min. ,500VDC
Dielectric Strength	500VAC for one minute
Shaft Radial Play	0.02Max. (450 g-load)
Shaft Axial Play	0.08Max. (450 g-load)
Max. radial force	75N (20mm from the flange)
Max. axial force	15N
Rotation	CW( See from Front Flange)



## ● Size 57mm High Torque Hybrid Stepping Motor Specifications

Model No.		Rated Voltage	Current /Phase	Resistance /Phase	Inductance /Phase	Holding Torque	# of Leads	Rotor Inertia	Weight	Detent Torque	Length
Single Shaft	Double Shaft	V	A	Ω	mH	kg-cm		g-cm <sup>2</sup>	kg	kg-cm	mm
FL57STH41-1006A	FL57STH41-1006B	5.7	1	5.7	5.4	3.9	6	120	0.45	0.21	41
FL57STH41-2006A	FL57STH41-2006B	2.8	2	1.4	1.4	3.9	6				
FL57STH41-3006A	FL57STH41-3006B	1.9	3	0.63	0.6	3.9	6				
FL57STH41-2804A	FL57STH41-2804B	2	2.8	0.7	1.4	5.5	4				
FL57STH51-1006A	FL57STH51-1006B	6.6	1	6.6	8.2	7.2	6	275	0.65	0.36	51
FL57STH51-2006A	FL57STH51-2006B	3.3	2	1.65	2.2	7.2	6				
FL57STH51-3006A	FL57STH51-3006B	2.2	3	0.74	0.9	7.2	6				
FL57STH51-2804A	FL57STH51-2804B	2.3	2.8	0.83	2.2	10.1	4				
FL57STH56-1006A	FL57STH56-1006B	7.4	1	7.4	10	9.0	6	300	0.7	0.4	56
FL57STH56-2006A	FL57STH56-2006B	3.6	2	1.8	2.5	9.0	6				
FL57STH56-3006A	FL57STH56-3006B	2.3	3	0.75	1.1	9.0	6				
FL57STH56-2804A	FL57STH56-2804B	2.5	2.8	0.9	2.5	12.6	4				
FL57STH76-1006A	FL57STH76-1006B	8.6	1	8.6	14	13.5	6	480	1	0.68	76
FL57STH76-2006A	FL57STH76-2006B	4.5	2	2.25	3.6	13.5	6				
FL57STH76-3006A	FL57STH76-3006B	3	3	1	1.6	13.5	6				
FL57STH76-2804A	FL57STH76-2804B	3.2	2.8	1.13	3.6	18.9	4				

### Dimension

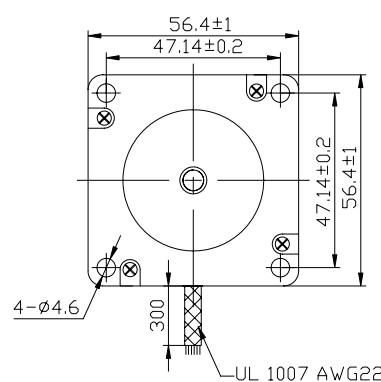
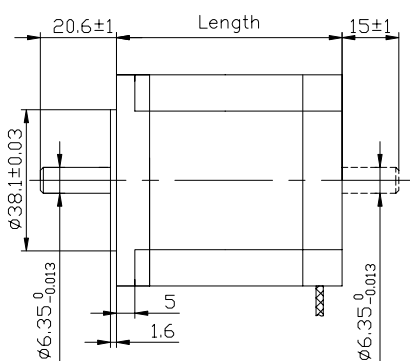

### Wiring Diagram

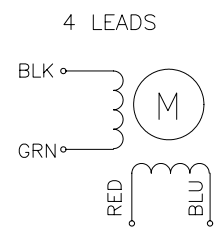
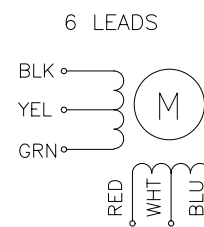



● Pull out Torque Curve

FL57STH41-1006A

VM: 30VDC; 1A /Phase () Driver: M542, half step

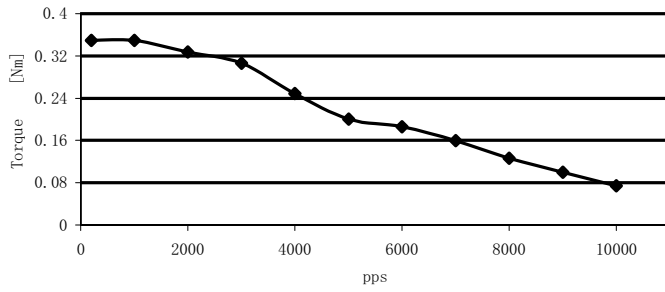

FL57STH41-2006A

VM: 30VDC; 2A /Phase () Driver: M542, half step

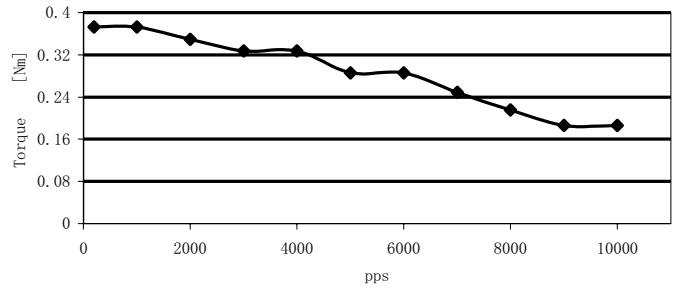

FL57STH41-3006A

VM: 30VDC; 3A /Phase () Driver: M542, half step

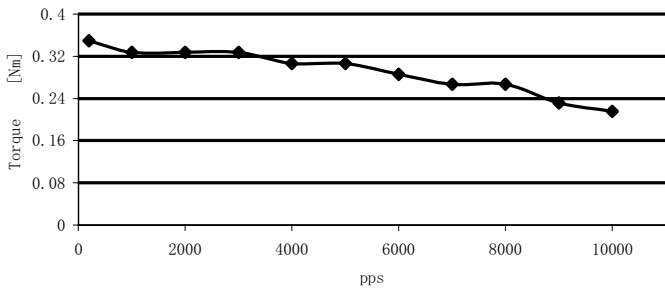

FL57STH41-2804A

VM: 30VDC; 2.7A /Phase () Driver: H860B, half step

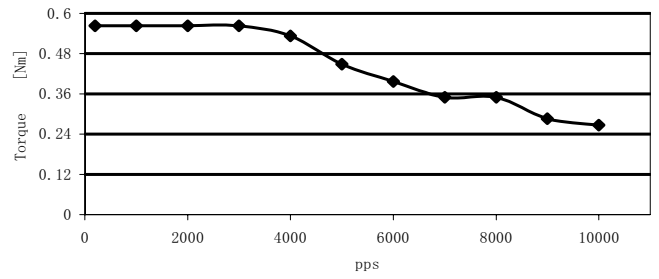

FL57STH51-1006A

VM: 30VDC; 1A /Phase () Driver: M542, half step

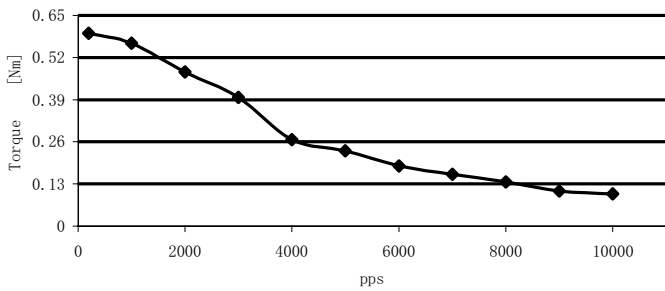

FL57STH51-2006A

VM: 30VDC; 2A /Phase () Driver: M542, half step

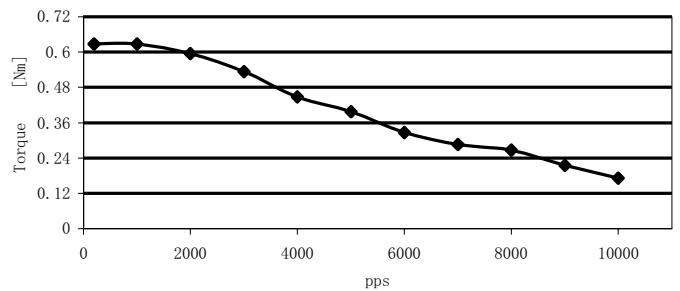

FL57STH51-3006A

VM: 30VDC; 3A /Phase () Driver: M542, half step

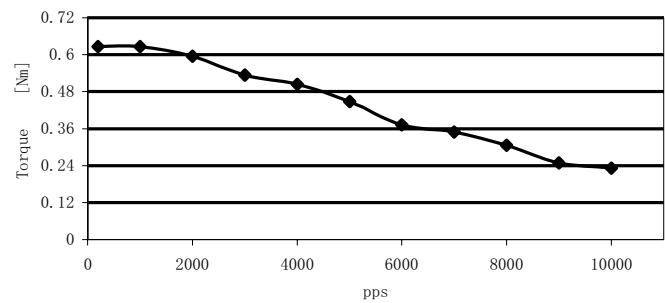

FL57STH51-2804A

VM: 30VDC; 2.7A /Phase () Driver: H860B, half step

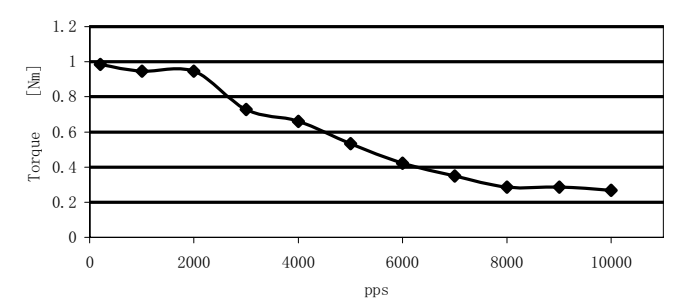

● Pull out Torque Curve

FL57STH56-1006A

VM: 30VDC; 1A /Phase () Driver: HA335, half step

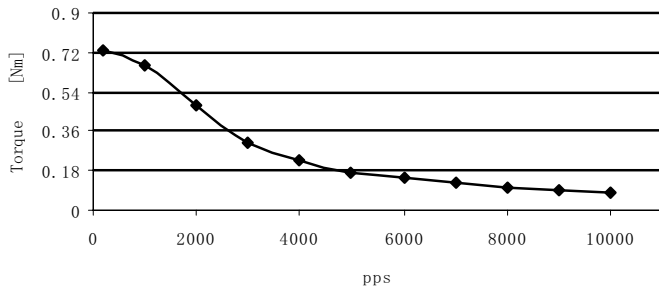

FL57STH56-2006A

VM: 30VDC; 2A /Phase () Driver: M542, half step

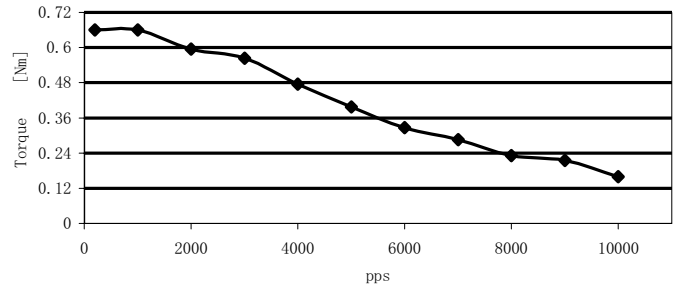

FL57STH56-3006A

VM: 30VDC; 2.7A /Phase () Driver: H860B, full step

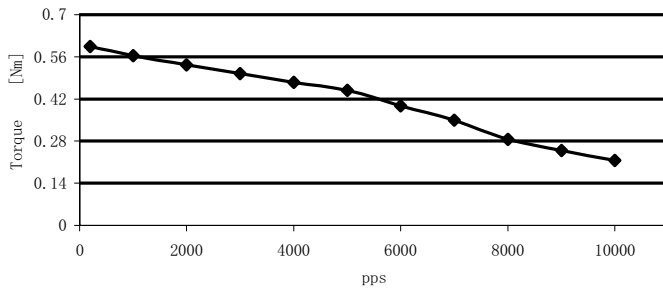

FL57STH56-2804A

VM: 30VDC; 2.7A /Phase () Driver: H860B, half step

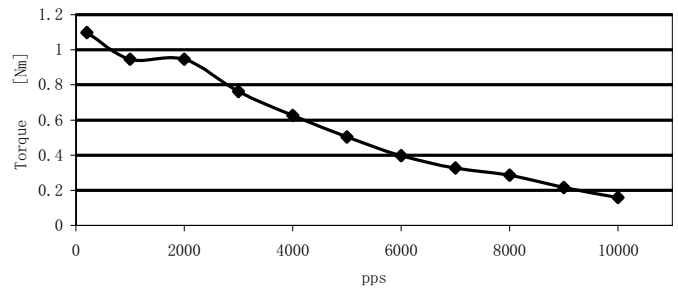

FL57STH76-1006A

VM: 30VDC; 1A /Phase () Driver: M542, half step

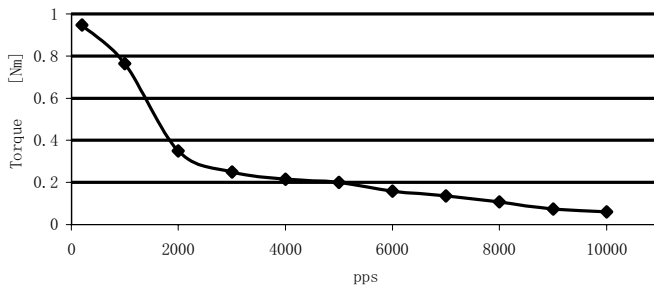

FL57STH76-2006A

VM: 30VDC; 2A /Phase () Driver: M542, half step

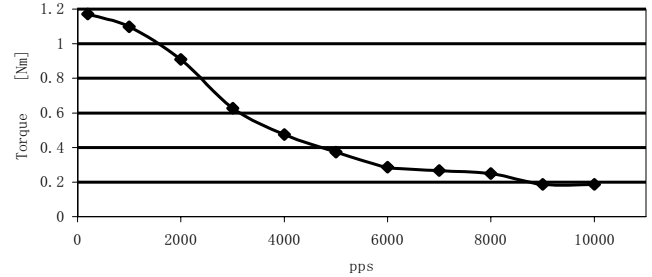

FL57STH76-3006A

VM: 30VDC; 2.7A /Phase () Driver: H860B, half step

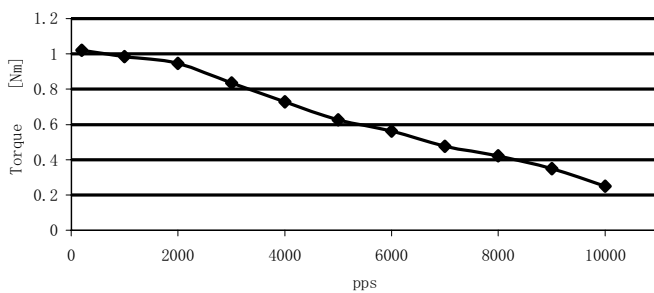

FL57STH76-2804A

VM: 30VDC; 2.7A /Phase () Driver: H860B, half step

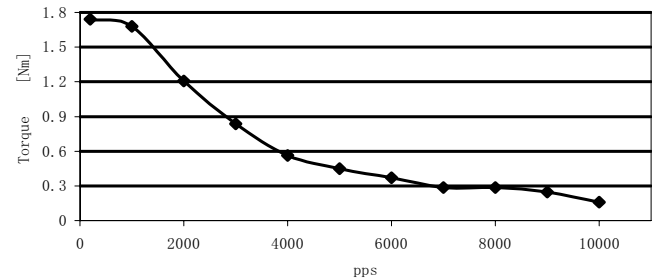

# 1.8° Size 60mm High Torque Hybrid Stepping Motor

A27

Item	Specifications
Step Angle	0.9°
Step Angle Accuracy	±5% (full step, no load)
Resistance Accuracy	±10%
Inductance Accuracy	±20%
Temperature Rise	80° C Max.(rated current,2 phase on)
Ambient Temperature	-20° C~+50° C
Insulation Resistance	100M Ω Min. ,500VDC
Dielectric Strength	500VAC for one minute
Shaft Radial Play	0.02Max. (450 g-load)
Shaft Axial Play	0.08Max. (450 g-load)
Max. radial force	75N (20mm from the flange)
Max. axial force	15N

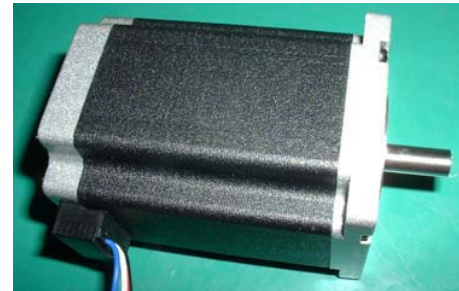

## ● Size 60mm High Torque Hybrid Stepping Motor Specifications

Model No.			Rated Voltage	Current /Phase	Resistance /Phase	Inductance /Phase	Holding Torque	# of Leads	Rotor Inertia	Weight	Detent Torque	Length
Single Shaft	Double Shaft		V	A	Ω	mH	kg-cm		g-cm <sup>2</sup>	kg	kg-cm	mm
FL60STH45-2008AF	FL60STH45-2008BF	unipolar	3	2	1.5	2	7.8	8	275	0.6	0.5	47
		parallel	2.1	2.8	0.75	2	11					
		series	4.2	1.4	3.0	8	11					
FL60STH56-2008AF	FL60STH56-2008BF	unipolar	3.6	2	1.8	3.6	11.7	8	300	0.77	0.7	56
		parallel	2.52	2.8	0.9	3.6	16.5					
		series	5.04	1.4	3.6	14.4	16.5					
FL60STH65-2008AF	FL60STH65-2008BF	unipolar	4.8	2	2.4	4.6	15	8	570	1.2	0.9	67
		parallel	3.36	2.8	1.2	4.6	21					
		series	6.72	1.4	4.8	18.4	21					
FL60STH86-2008AF	FL60STH86-2008BF	unipolar	6	2	3	6.8	22	8	840	1.4	1.0	88
		parallel	4.17	2.8	1.5	6.8	31					
		series	8.4	1.4	6	27.2	31					

## ● Dimension

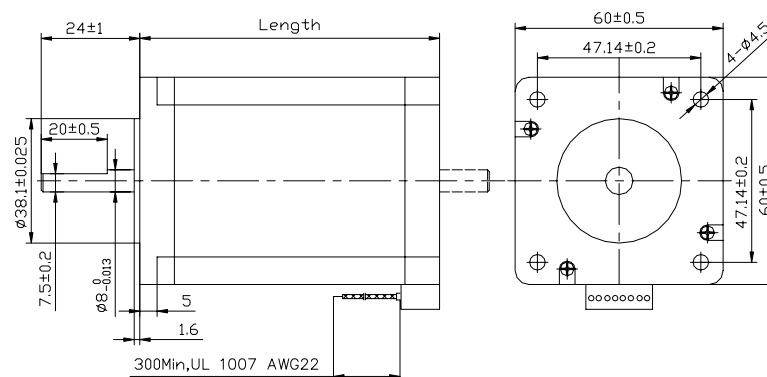

## ● Wiring Diagram

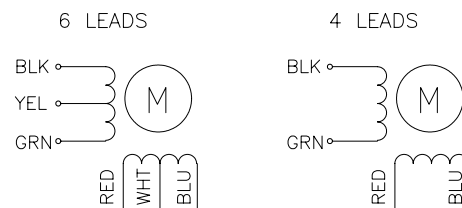

# ● Pull out Torque Curve

FL60STH45-2008AF

VM: 30VDC; 2.0A /Phase () Driver: M542, half step, parallel

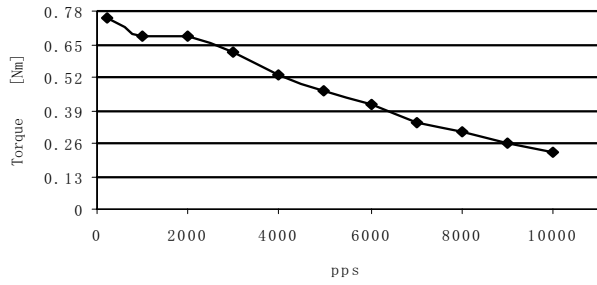

FL60STH56-2008AF

VM: 30VDC; 2.0A /Phase () Driver: M542, half step, parallel

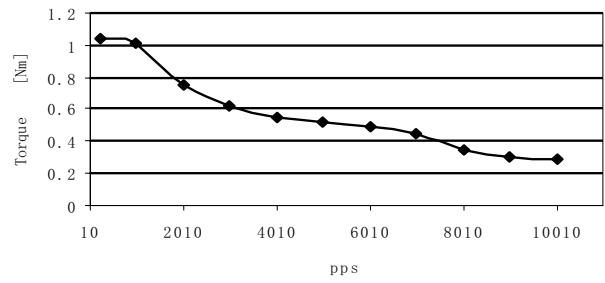

FL60STH65-2008AF

VM: 30VDC; 2.0A /Phase () Driver: M542, half step, parallel

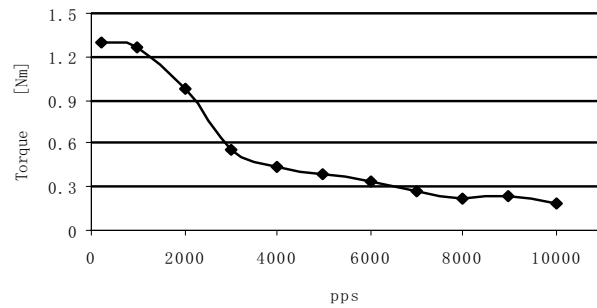

FL60STH86-2008AF

VM: 30VDC; 2.0A /Phase () Driver: M542, half step, parallel

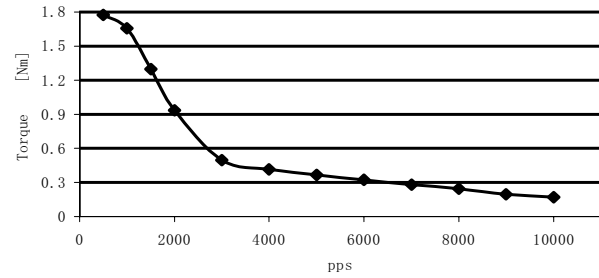

# 1.8° Size 86mm Round High Torque Hybrid Stepping Motor

A29

Item	Specifications
Step Angle	1.8°
Step Angle Accuracy	± 5% (full step, no load)
Resistance Accuracy	± 10%
Inductance Accuracy	± 20%
Temperature Rise	80° C Max.(rated current,2 phase on)
Ambient Temperature	-20° C~+50° C
Insulation Resistance	100MΩ Min. ,500VDC
Dielectric Strength	820VAC , 1s , 3mA
Shaft Radial Play	0.02Max. (450 g-load)
Shaft Axial Play	0.08Max. (450 g-load)
Max. radial force	220N (20mm from the flange)
Max. axial force	60N



## ● Size 86mm High Torque Hybrid Stepping Motor Specifications

Model No.	Rated Voltage	Current /Phase	Resistance /Phase	Inductance /Phase	Holding Torque	# of Leads	Rotor Inertia	Weight	Detent Torque	Length
	V	A	Ω	mH	Kg.cm		g-cm <sup>2</sup>	kg	kg-cm	mm
FL86ST67-2808A	3.64	2.8	1.3	5.1	28	8	660	1.6		67
FL86ST94-2808A	4.76	2.8	1.7	7.7	48	8	1200	2.4		94
FL86ST125-3508A	4.97	3.5	1.42	7.9	76	8	1800	3.6		125

## ● Dimension

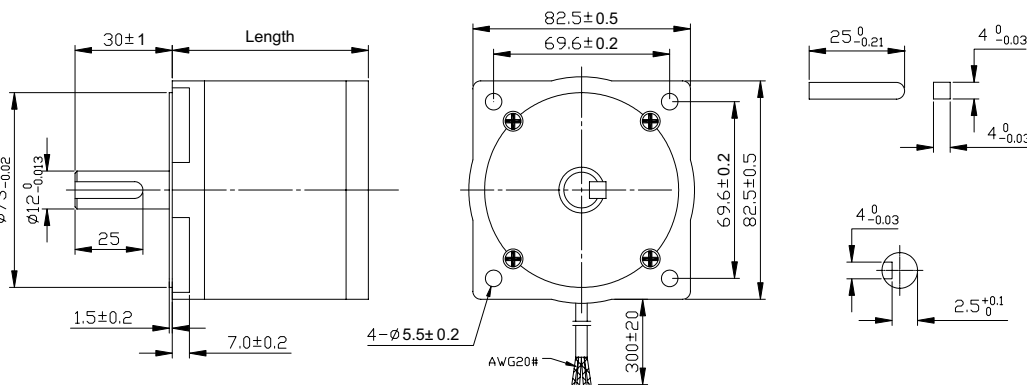

## ● Pull out Torque Curve

FL86ST67-2808A

VM: 100VAC; 3.96A /Phase() Driver: MD2278, 400pμl/rev, PARALLEL

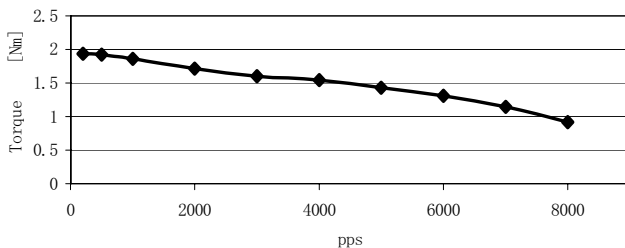

FL86ST94-2808A

VM: 100VAC; 3.96A /Phase() Driver: MD2278, 400pμl/rev, PARALLEL

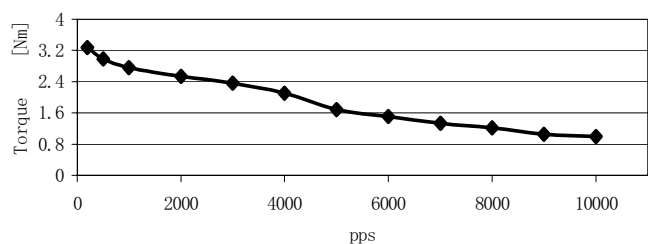

FL86ST125-3508A

VM: 100VAC; 4.71A /Phase() Driver: MD2278, 400pμl/rev, PARALLEL

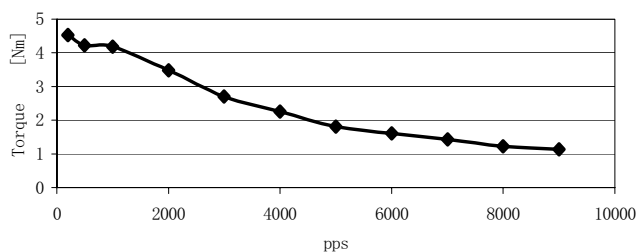

# 1.8° Size 86mm Round Standard Hybrid Stepping Motor A30

## ● General Specification for Hybrid Stepping Motor

Item	Specifications
Step Angle	1.8°
Step Angle Accuracy	± 5% (full step, no load)
Resistance Accuracy	± 10%
Inductance Accuracy	± 20%
Temperature Rise	80° C Max.(rated current,2 phase on)
Ambient Temperature	-20° C~+50° C
Insulation Resistance	100M Ω Min. ,500VDC
Dielectric Strength	1500VAC for one minute
Shaft Radial Play	0.02Max. (450 g-load)
Shaft Axial Play	0.08Max. (450 g-load)
Max. radial force	220N (20mm from the flange)
Max. axial force	60N
Rotation	CW( See from Front Flange)



## ● Size 86mm High Torque Hybrid Stepping Motor Specifications

Model No.		Rated Voltage	Current /Phase	Resistance /Phase	Inductance /Phase	Holding Torque	# of Leads	Rotor Inertia	Weight	Detent Torque	Length
Single Shaft	Double Shaft	V	A	Ω	mH	Kg.cm		g-cm <sup>2</sup>	kg	kg-cm	mm
FL86ST62-4506A	FL86ST62-4506B	1.8	4.5	0.4	1.4	13	6	560	1.5	0.8	62
FL86ST62-1256A	FL86ST62-1256B	5.5	1.25	4.4	14	13	6				
FL86ST62-1406A	FL86ST62-1406B	0.7	14	20	60	13	6				
FL86ST62-5904A	FL86ST62-5904B	1.33	5.9	0.23	1.5	18	4				
FL86ST94-4006A	FL86ST94-4006B	3.0	4.0	0.75	4.5	26	6	1100	2.6	2.4	94
FL86ST94-2006A	FL86ST94-2006B	6.0	2.0	3.0	13	26	6				
FL86ST94-1006A	FL86ST94-1006B	12	1	12	72	26	6				
FL86ST94-5604A	FL86ST94-5604B	2.1	5.6	0.38	3.9	35	4				
FL86ST134-6706A	FL86ST134-6706B	3.0	6.7	0.45	2	36	6	1800	3.6	3.6	134
FL86ST134-4006A	FL86ST134-4006B	5.0	4.0	1.25	6.6	36	6				
FL86ST134-1806A	FL86ST134-1806B	12	1.8	6.5	41	36	6				
FL86ST134-5604A	FL86ST134-5604B	3.5	5.6	0.63	6.6	50	4				

## ● Dimension

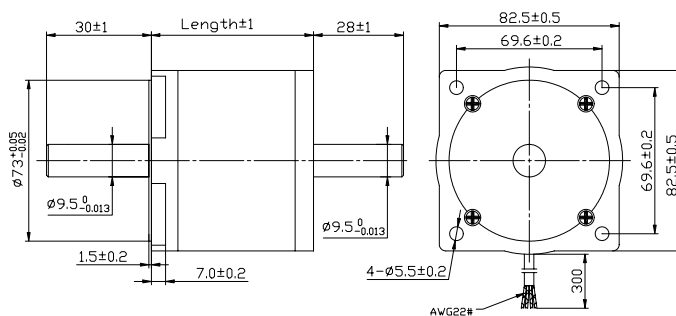

## Wiring Diagram

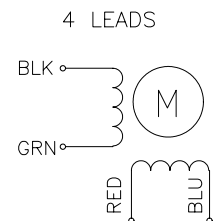
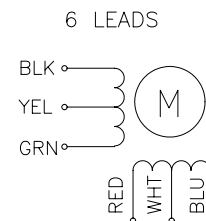

● Pull out Torque Curve

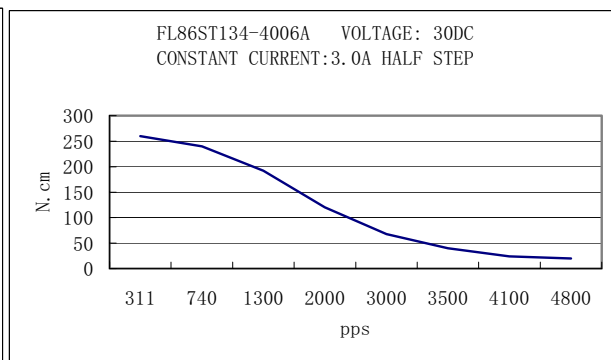
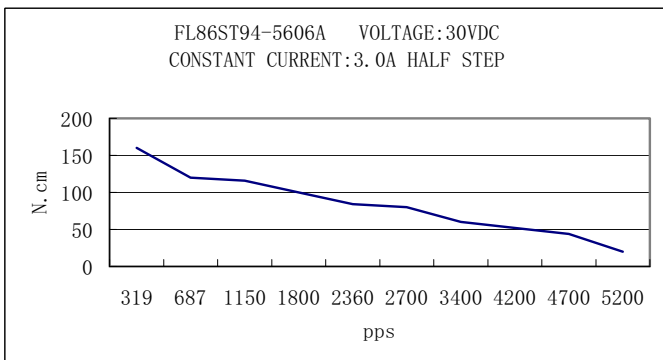
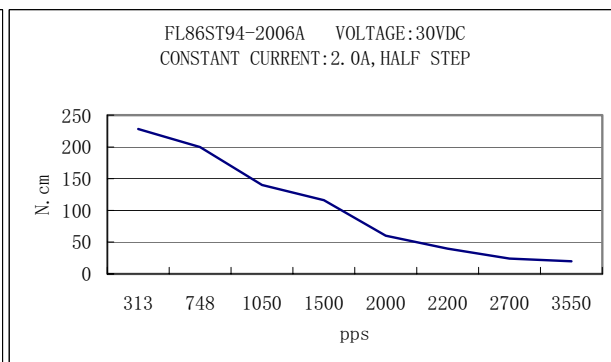
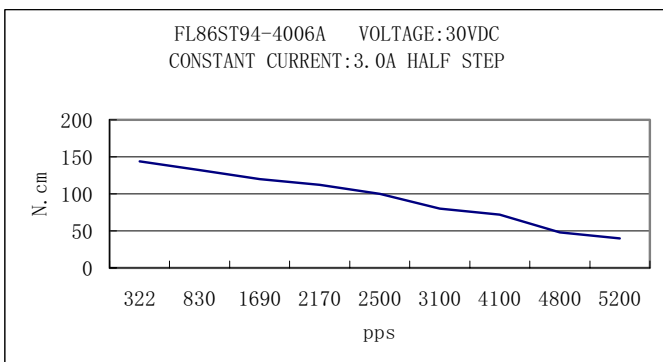
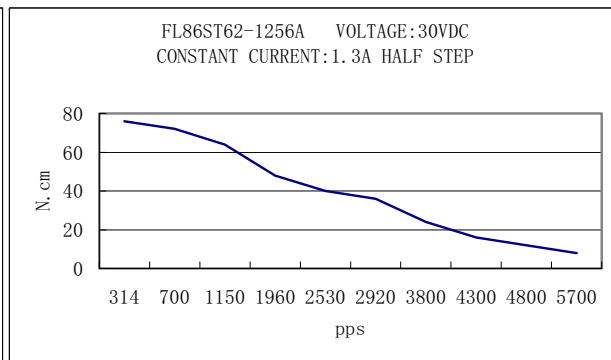
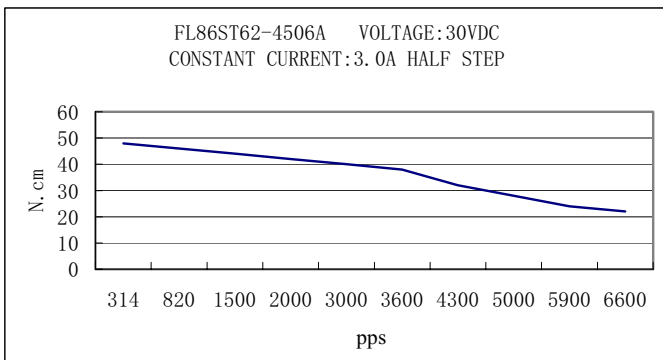

# 1.8° Size 86mm High Torque Hybrid Stepping Motor

A32

Item	Specifications
Step Angle	1.8°
Step Angle Accuracy	± 5% (full step, no load)
Resistance Accuracy	± 10%
Inductance Accuracy	± 20%
Temperature Rise	80° C Max.(rated current,2 phase on)
Ambient Temperature	-20° C~+50° C
Insulation Resistance	100M Ω Min. ,500VDC
Dielectric Strength	820VAC , 1s , 3mA
Shaft Radial Play	0.02Max. (450 g-load)
Shaft Axial Play	0.08Max. (450 g-load)
Max. radial force	220N (20mm from the flange)
Max. axial force	60N

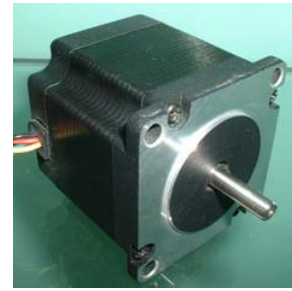

## ● Size 86mm High Torque Hybrid Stepping Motor Specifications

Model No.		Current /Phase	Resistance /Phase	Inductance /Phase	Holding Torque (Bipolar)	# of Leads	Rotor Inertia	Weight	Detent Torque	Length
Single Shaft	Double Shaft	A	Ω	mH	Kg.cm	#	g-cm <sup>2</sup>	kg	kg-cm	mm
FL86STH65-5904A	FL86STH65-5904B	5.9	0.28	1.7	34	4	1000	1.7	0.8	65
FL86STH65-2808A	FL86STH65-2808B	2.8	1.4	3.9	34	8				
FL86STH80-5504A	FL86STH80-5504B	5.5	0.46	4	46	4	1400	2.3	1.2	80
FL86STH80-4208A	FL86STH80-4208B	4.24	0.75	3.4	46	8				
FL86STH118-6004A	FL86STH118-6004B	6	0.6	6.5	87	4	2700	3.8	2.4	118
FL86STH118-4208A	FL86STH118-4208B	4.2	0.9	6	87	8				
FL86STH156-6204A	FL86STH156-6204B	6.2	0.75	9	122	4	4000	5.4	3.6	156
FL86STH156-4208A	FL86STH156-4208B	4.2	1.25	8	122	8				

## ● Dimension

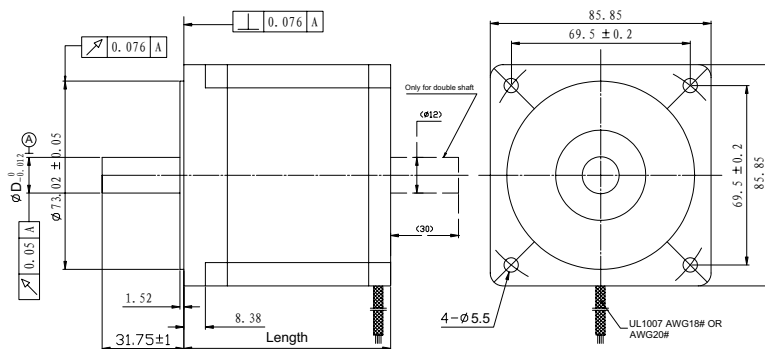

FL86STH65-2808A FL86STH65-2808A	
FL86STH80-5504A FL86STH80-4208A	
FL86STH118-6004A FL86STH118-4208A	
FL86STH156-6204A FL86STH156-4208A	

## ● WIRE DIAGRAM

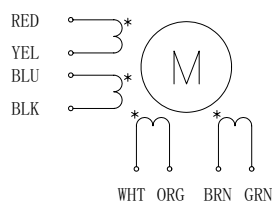
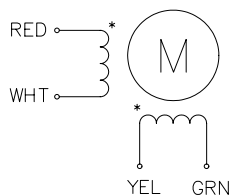



- Pull out Torque Curve

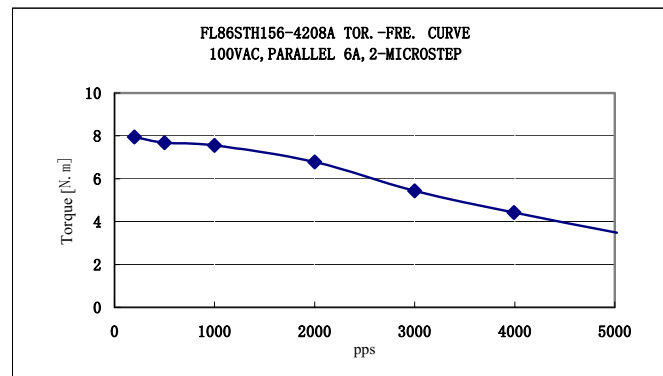
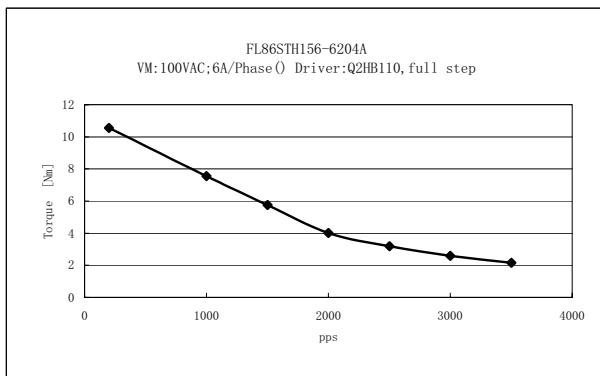
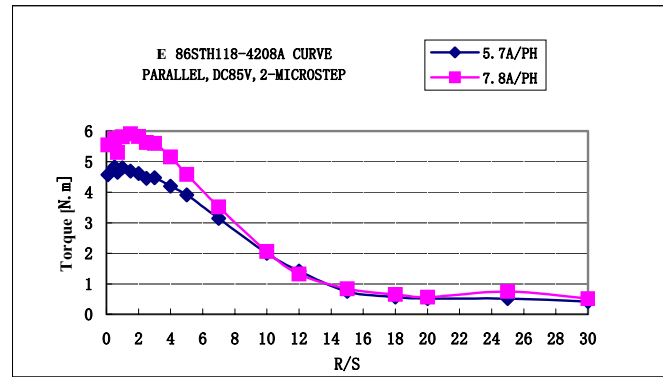
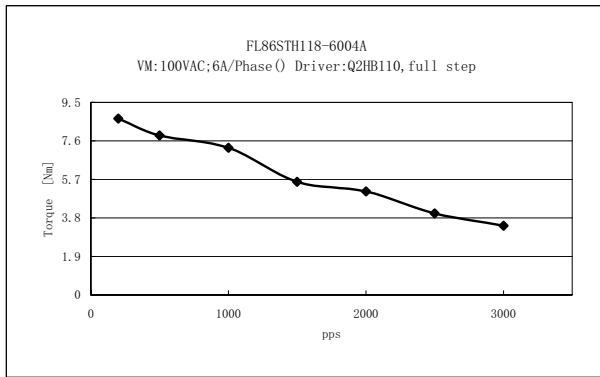
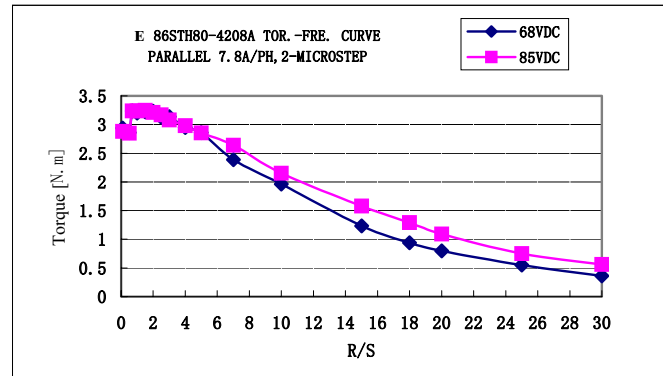
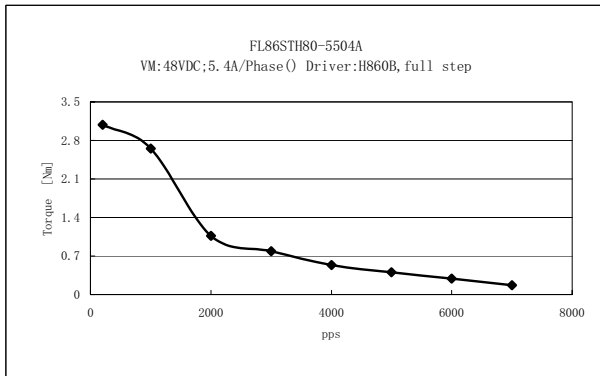
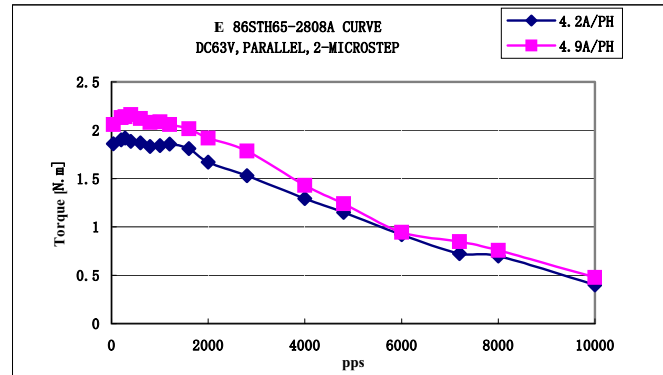
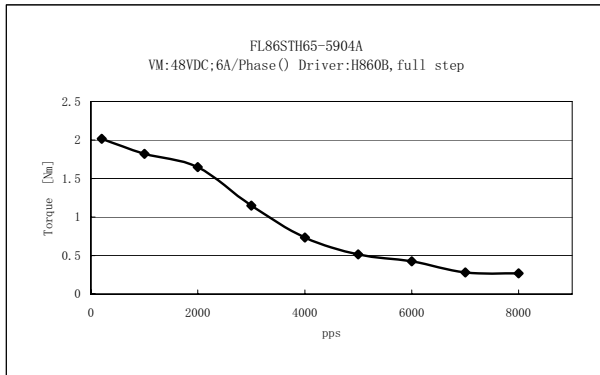

Item	Specifications
Step Angle	1.8°
Step Angle Accuracy	±5% (full step, no load)
Resistance Accuracy	±10%
Inductance Accuracy	±20%
Temperature Rise	80° C Max.(rated current,2 phase on)
Ambient Temperature	-20° C~+50° C
Insulation Resistance	100M Ω Min. ,500VDC
Dielectric Strength	1800VAC , 1s , 5mA
Shaft Radial Play	0.02Max. (450 g-load)
Shaft Axial Play	0.08Max. (450 g-load)
Max. radial force	220N (20mm from the flange)
Max. axial force	60N

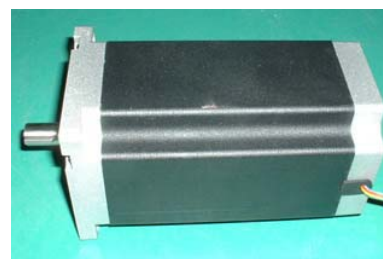

## ● Size 110mm High Torque Hybrid Stepping Motor Specifications

Model No.	Current /Phase	Resistance /Phase	Inductance /Phase	Holding Torque	# of Leads	Rotor Inertia	Weight	Detent Torque	Length
Single shaft	A	Ω	mH	N.m	#	g-cm <sup>2</sup>	kg	kg-cm	mm
FL110STH99-5504A	5.5	0.9	12	11.2	4	5500	5	3	99
FL110STH150-6504A	6.5	0.8	15	21	4	10900	8.4	5.9	150
FL110STH201-8004A	8	0.67	12	28	4	16200	11.7	7.5	201

## ● Dimension

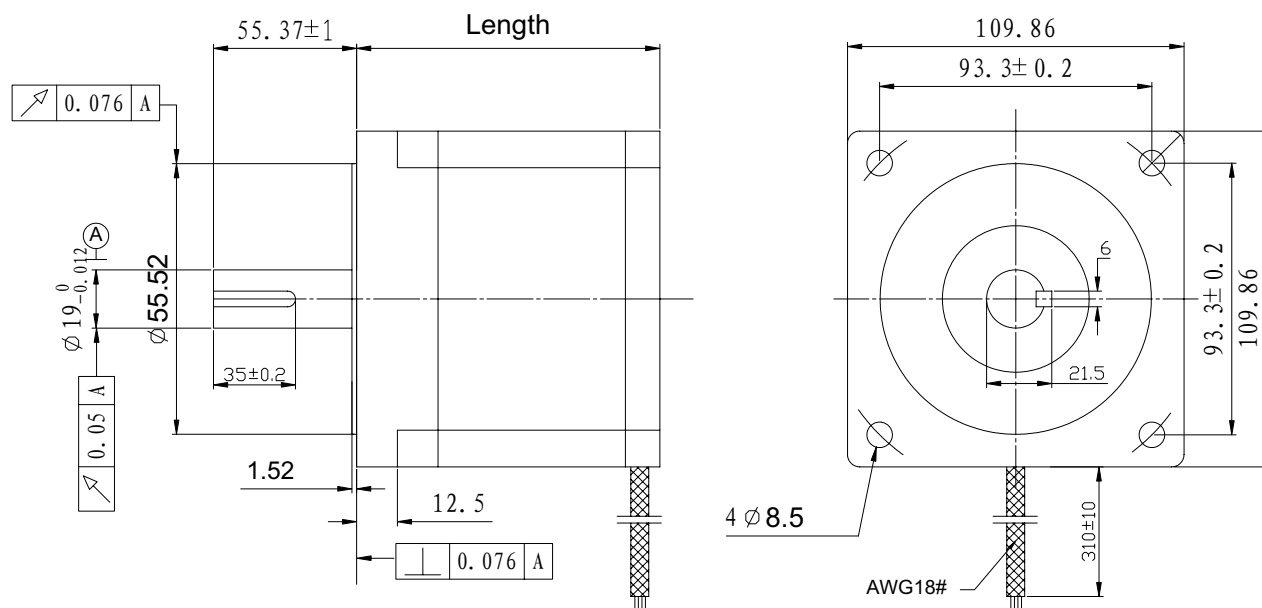

## Wiring Diagram

4 LEADS

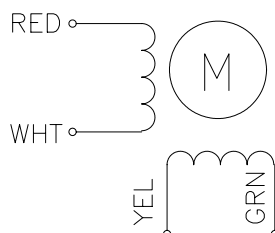

- Pull out Torque Curve

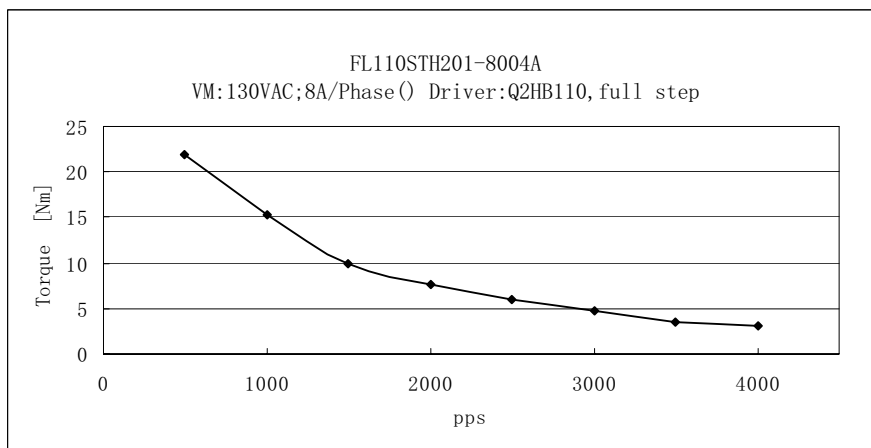
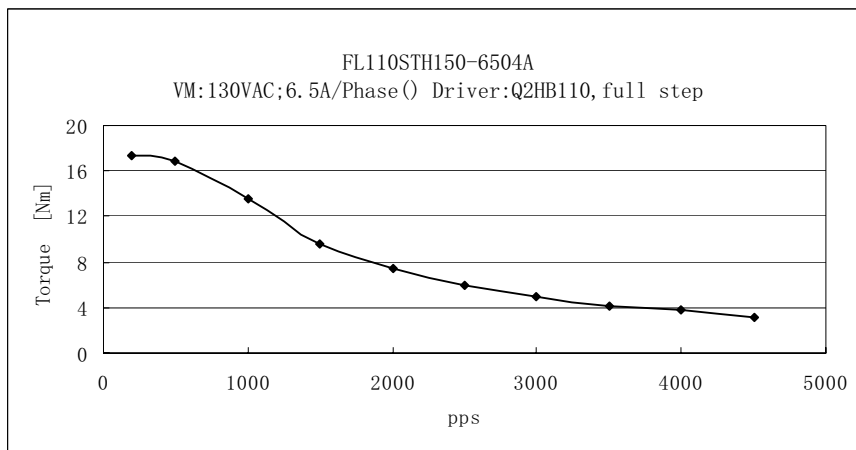
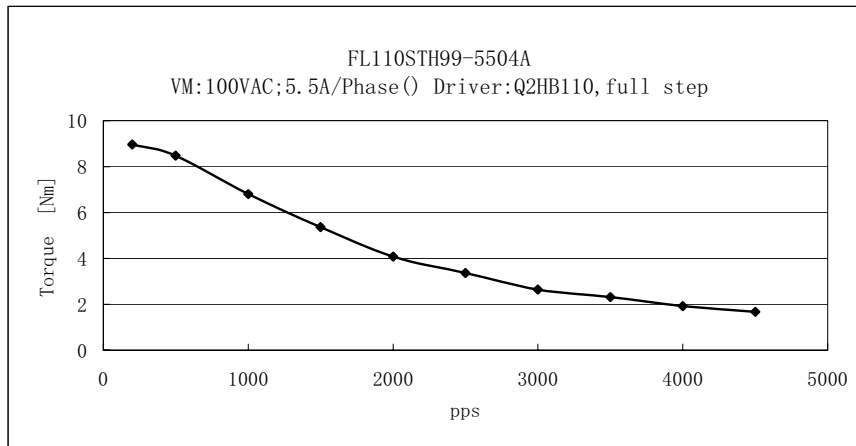

# 0.72° , 1.2° , 1.5° and 1.8° Size 110mm Hybrid Stepping Motor A36

## ● General Specification for Hybrid Stepping Motor

Item	Specifications
Step Angle	0.72/1.2/1.5/ 1.8°
Step Angle Accuracy	± 5% (full step, no load)
Resistance Accuracy	± 10%
Inductance Accuracy	± 20%
Temperature Rise	80° C Max.(rated current,2 phase on)
Ambient Temperature	-20° C~+50° C
Insulation Resistance	100MΩ Min. ,500VDC
Dielectric Strength	1500VAC for one minute
Shaft Radial Play	0.02Max. (450 g-load)
Shaft Axial Play	0.08Max. (450 g-load)
Max. radial force	220N (20mm from the flange)
Max. axial force	60N
Rotation	CW( See from Front Flange)

## ● Size 110mm Hybrid Stepping Motor Specifications

Model No.	No. of phase	Step angle	Rated Voltage	Current /Phase	No Load Run Frequency	Holding Torque	Rotor Inertia	Length	Shaft Dimention Φ D	Flange Dimention Φ D1	KEY A	Wiring Diagram
Single shaft		degree	V	A	KHz	Kg.cm	kg-cm <sup>2</sup>	mm	mm	mm		
FL110BYG2500	2	1.8	120-310	4.0	≥15	8.0	6.0	86	16 <sup>-0.01 -0.022</sup>	85 <sup>0 -0.017</sup>	4×9	1
FL110BYG2501	2	1.8	120-310	4.0	≥15	12.0	11.0	144	16 <sup>-0.01 -0.022</sup>	85 <sup>0 -0.017</sup>	4×9	1
FL110BYG2502	2	1.8	120-310	5.0	≥20	20.0	15.0	182	16 <sup>-0.01 -0.022</sup>	85 <sup>0 -0.017</sup>	4×9	1
FL110BYG2600	2	1.5	120-310	4.0	≥15	8.0	6.0	86	16 <sup>-0.01 -0.022</sup>	85 <sup>0 -0.017</sup>	4×9	1
FL110BYG2601	2	1.5	120-310	4.0	≥20	12.0	11.0	142	16 <sup>-0.01 -0.022</sup>	85 <sup>0 -0.017</sup>	4×9	1
FL110BYG2602	2	1.5	120-310	5.0	≥20	20.0	15.0	184	16 <sup>-0.01 -0.022</sup>	85 <sup>0 -0.017</sup>	4×9	1
FL110BYG3500	3	1.2	120-310	3.0	≥25	8.0	6.0	100	19 <sup>-0.013 -0.028</sup>	85 <sup>0 -0.017</sup>	6×30	2
FL110BYG3501	3	1.2	120-310	3.0	≥30	12.0	11.0	144	19 <sup>-0.013 -0.028</sup>	85 <sup>0 -0.017</sup>	6×30	2
FL110BYG3502	3	1.2	120-310	3.0	≥30	16.0	15.0	182	19 <sup>-0.013 -0.028</sup>	85 <sup>0 -0.017</sup>	6×30	2
FL110BYG3503	3	1.2	120-310	3.0	≥30	20.0	18.0	261	19 <sup>-0.013 -0.028</sup>	85 <sup>0 -0.017</sup>	6×30	2
FL110BYG5501	5	0.72	120-310	3.0	≥20	10.0	11.0	144	16 <sup>-0.01 -0.022</sup>	56 <sup>0 -0.017</sup>	5×25	1
FL110BYG5502	5	0.72	120-310	5.0	≥20	16.0	15.0	189	16 <sup>-0.01 -0.022</sup>	56 <sup>0 -0.017</sup>	5×25	1
FL110BYG5503	5	0.72	120-310	5.0	≥20	20.0	18.0	231	19 <sup>-0.013 -0.028</sup>	56 <sup>0 -0.017</sup>	5×25	1

## Dimension

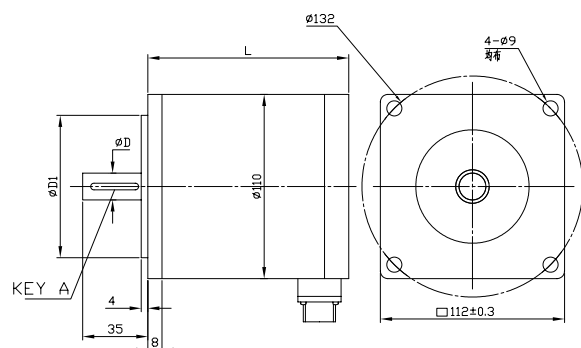

## Wiring Diagram

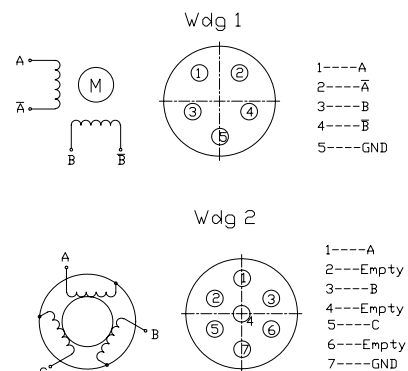

● General Specification for Hybrid Stepping Motor

Item	Specifications
Step Angle	0.72° /1.2° /1.8°
Step Angle Accuracy	± 5% (full step, no load)
Resistance Accuracy	± 10%
Inductance Accuracy	± 20%
Temperature Rise	80° C Max.(rated current,2 phase on)
Ambient Temperature	-20° C~+50° C
Insulation Resistance	100MΩ Min. ,500VDC
Dielectric Strength	1500VAC for one minute
Shaft Radial Play	0.02Max. (450 g-load)
Shaft Axial Play	0.08Max. (450 g-load)
Max. radial force	220N (20mm from the flange)
Max. axial force	60N
Rotation	CW( See from Front Flange)

● Size 110mm Hybrid Stepping Motor Specifications

Model No.	No. of phase	Step angle	Rated Voltage	Current /Phase	No Load Run Frequency	Holdin g Torque	Rotor Inertia	Length	Shaft Dimention Φ D	Flange Dimention Φ D1	KEY A	Wiring Diagram
		degree	V	A	KHz	Kg.cm	kg-cm <sup>2</sup>	mm	mm	mm		
FL130BYG2501	2	1.8	120-310	6.0	≥20	27	33	165	19 <sup>-0.013</sup> <sub>-0.028</sub>	100 <sup>0</sup> <sub>-0.023</sub>	5×25	1
FL130BYG2502	2	1.8	120-310	7.0	≥15	40	48	230	19 <sup>-0.013</sup> <sub>-0.028</sub>	100 <sup>0</sup> <sub>-0.023</sub>	5×25	1
FL130BYG2503	2	1.8	120-310	7.0	≥12	50	60	270		100 <sup>0</sup> <sub>-0.023</sub>		1
FL130BYG3501	3	1.2	80-325	6.0	≥15	25	33	165	19 <sup>-0.013</sup> <sub>-0.028</sub>	100 <sup>0</sup> <sub>-0.023</sub>	5×25	
FL130BYG3502	3	1.2	80-325	6.0	≥15	37	48	230	19 <sup>-0.013</sup> <sub>-0.028</sub>	100 <sup>0</sup> <sub>-0.023</sub>	5×25	
FL130BYG3503	3	1.2	80-325	6.0	≥15	50	60	270		100 <sup>0</sup> <sub>-0.023</sub>		
FL130BYG5501	5	0.72	120-310	5.0	≥20	20	33	165	19 <sup>-0.013</sup> <sub>-0.028</sub>	100 <sup>0</sup> <sub>-0.023</sub>	5×25	2
FL130BYG5502	5	0.72	120-310	5.0	≥20	30	48	230	19 <sup>-0.013</sup> <sub>-0.028</sub>	100 <sup>0</sup> <sub>-0.023</sub>	5×25	2
FL130BYG5503	5	0.72	120-310	5.0	≥15	40	60	270		100 <sup>0</sup> <sub>-0.023</sub>		2

Dimension

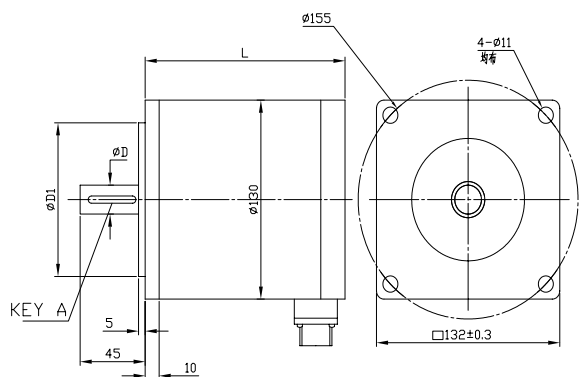

Wiring Diagram

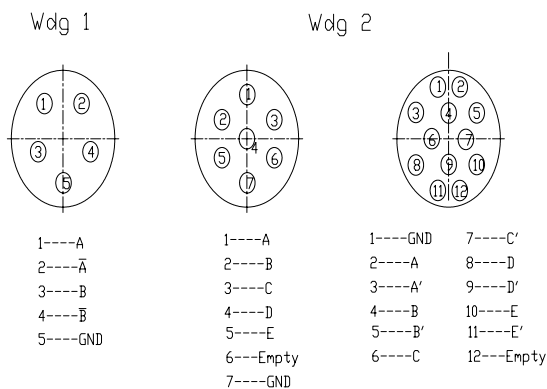

## ● General Specification for High Torque Hybrid Stepping Motor

Item	Specifications
Step Angle	1.2°
Step Angle Accuracy	±5% (full step, no load)
Resistance Accuracy	±10%
Inductance Accuracy	±20%
Temperature Rise	80° C Max.(rated current)
Ambient Temperature	-20° C~+50° C
Insulation Resistance	100MΩ Min. ,500VDC
Dielectric Strength	500VAC for one minute
Shaft Radial Play	0.02Max. (450 g-load)
Shaft Axial Play	0.08Max. (450 g-load)
Max. radial force	75N (20mm from the flange)
Max. axial force	15N
Insulation class	F



## ● Size 57mm 3-Phase Hybrid Stepping Motor Specifications

Model No.	Voltage /Phase	Inductance /Phase	Resistance /Phase	Current /Phase	Holding Torque	Detent Torque	Rotor Inertia	Weight	Length (L)
unit	V	mH	Ω	A	N.m	N.cm	g-cm <sup>2</sup>	kg	mm
FL573P42-5206A	6.76	1.4	1.3	5.2	0.45	2.1	110	0.45	42
FL573P56-5606A	4	1.7	0.7	5.6	0.90	4	300	0.75	56
FL573P79-5806A	6	2.4	1.05	5.8	1.5	6.8	480	1.10	79

## ● Dimension

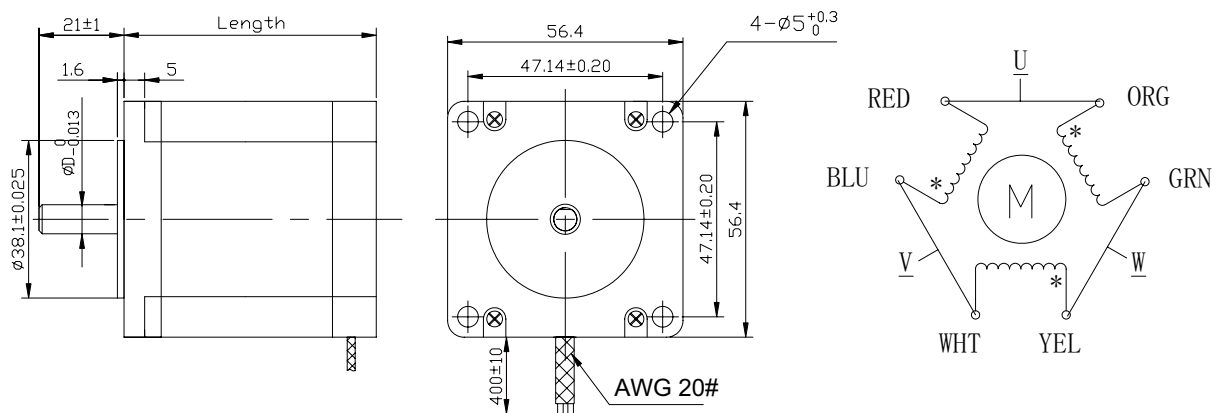

For FL573P42-5206A & FL573P56-5606A, “D” is 6.35, for FL573P79-5806A, “D” is 8.

## ● Pull out Torque Curve

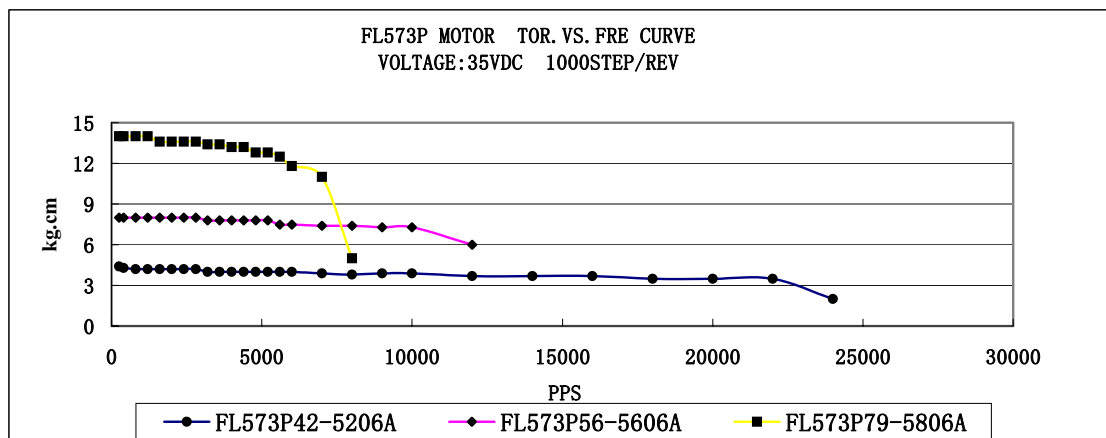

## ● General Specification for High Torque Hybrid Stepping Motor

Item	Specifications
Step Angle	1.2°
Step Angle Accuracy	±5% (full step, no load)
Resistance Accuracy	±10%
Inductance Accuracy	±20%
Temperature Rise	80° C Max.(rated current)
Ambient Temperature	-20° C~+50° C
Insulation Resistance	100M Ω Min. ,500VDC
Dielectric Strength	1800VAC , 1s , 3mA
Shaft Radial Play	0.02Max. (450 g-load)
Shaft Axial Play	0.08Max. (450 g-load)
Max. radial force	220N (20mm from the flange)
Max. axial force	60N
Insulation class	F



## ● Size 86mm 3-Phase Hybrid Stepping Motor Specifications

Model No.	Voltage /phase	Current /Phase	Resistance /Phase	Inductance /Phase	Holding Torque	Ratedng Torque	Rotor Inertia	Weight	Length
unit	VDC	A	Ω	mH	N.m	N.m	g-cm <sup>2</sup>	kg	mm
FL863P67-01	325	1.75	4.25	12.3	2.26	2	1100	1.65	67
FL863P97-01	325	2	5.4	23	4.52	4	2320	2.7	97
FL863P97-02	40	5.8	0.9	3.2	4.52	4			
FL863P127-01	325	2.25	9	41	6.78	6	3300	3.8	127
FL863P127-02	40	5.2	2.75	13.7	6.78	6			

## ● Dimension

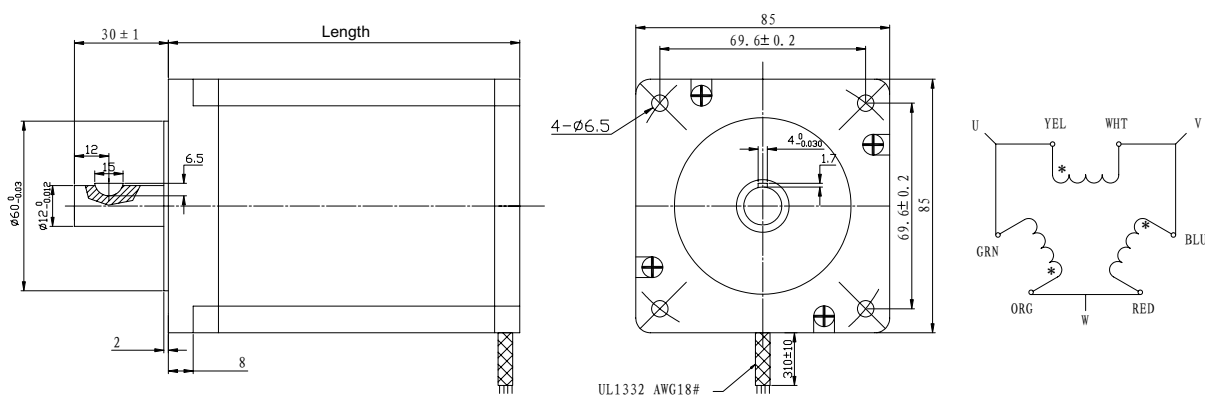

## Pull out Torque Curve

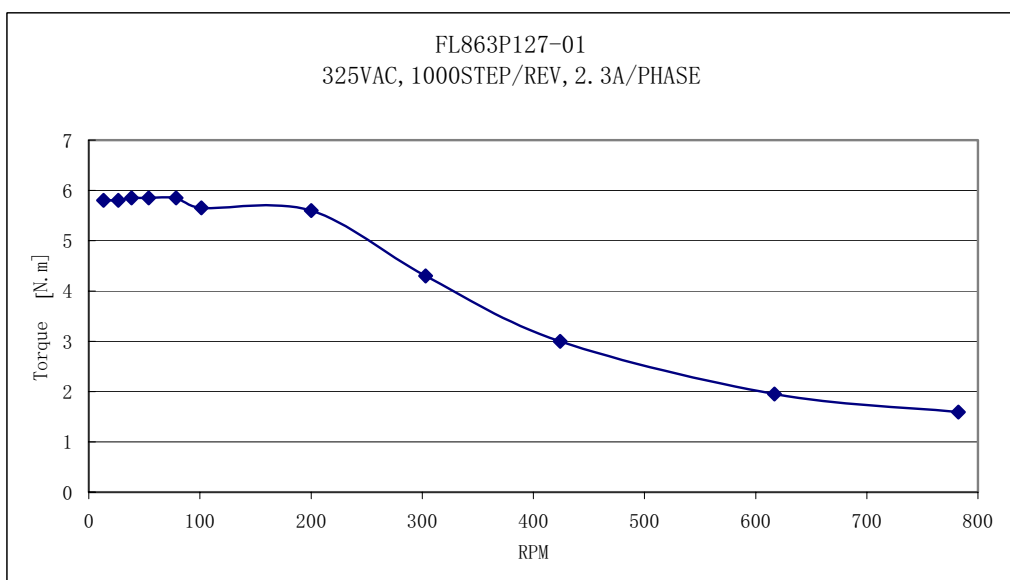
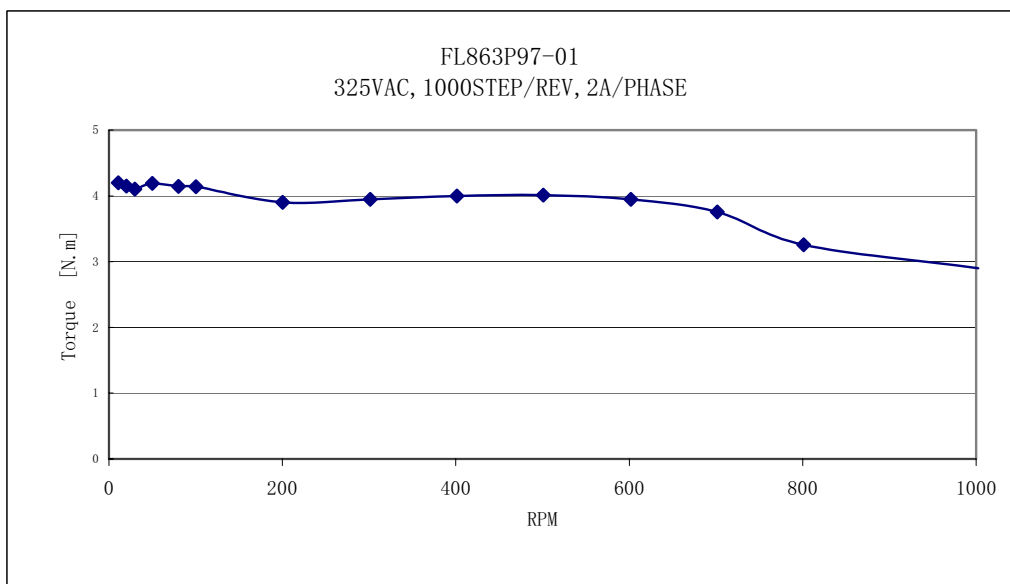
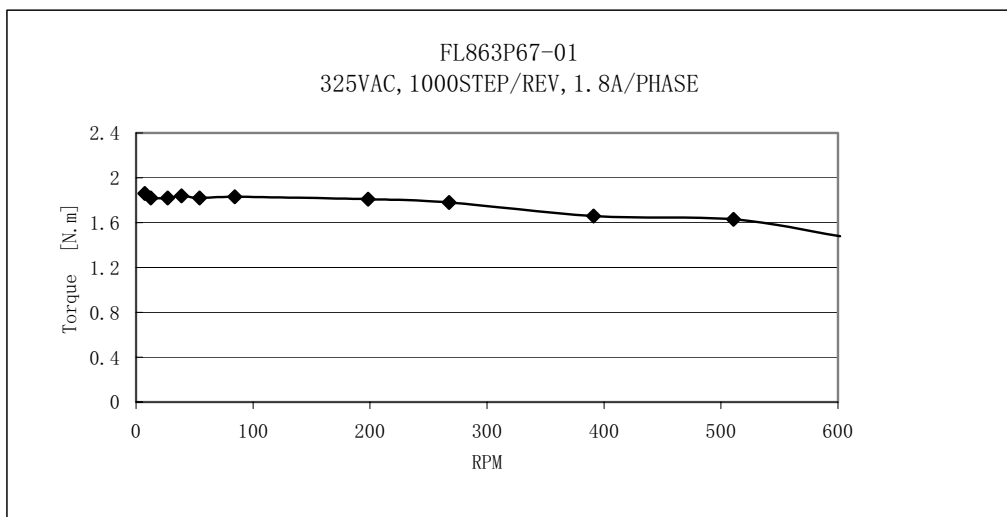



## ● General Specification for High Torque Hybrid Stepping Motor

Item	Specifications
Step Angle	1.2°
Step Angle Accuracy	± 5% (full step, no load)
Resistance Accuracy	± 10%
Inductance Accuracy	± 20%
Temperature Rise	80° C Max.(rated current)
Ambient Temperature	-20° C~+50° C
Insulation Resistance	100M Ω Min. ,500VDC
Dielectric Strength	1800VAC , 1s ,5mA
Shaft Radial Play	0.02Max. (450 g-load)
Shaft Axial Play	0.08Max. (450 g-load)
Max. radial force	220N (20mm from the flange)
Max. axial force	60N
Insulation class	F



## ● Siz 110mm 3Phase Hybrid Stepping Motor Specifications

Model No.	Max. starting speed	Voltage /Phase	Current /Phase	Holding Torque	Ratedng Torque	Rotor Inertia	Weight	Length
unit	Rpm/s	VDC	A	N.m	N.m	g-cm <sup>2</sup>	kg	mm
FL1103P170-01	4.7	325	4.1	13.92	12	10500	8	173

## ● Dimension

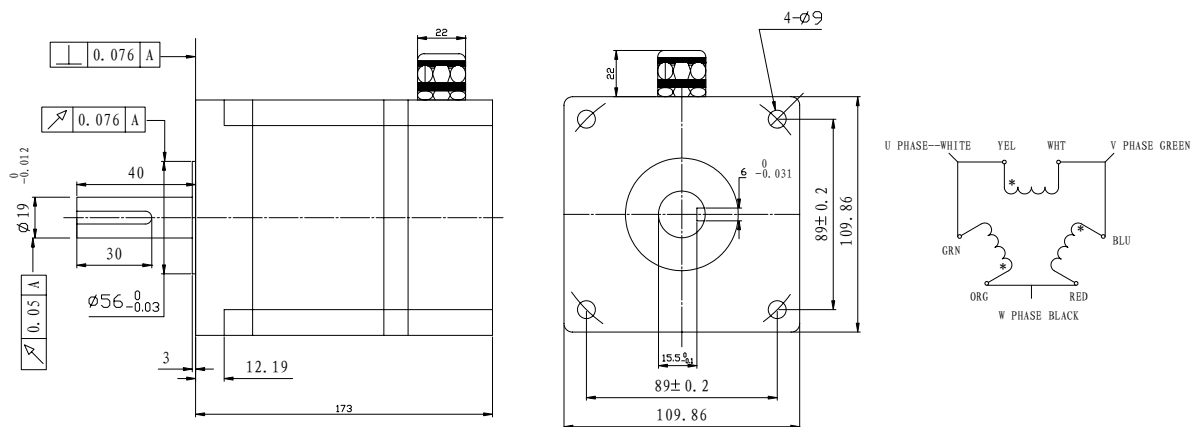

## ● Pull out Torque Curve

FL11039170-01  
VM: 220VAC, 4A/PHASE, 1000STEP/REV

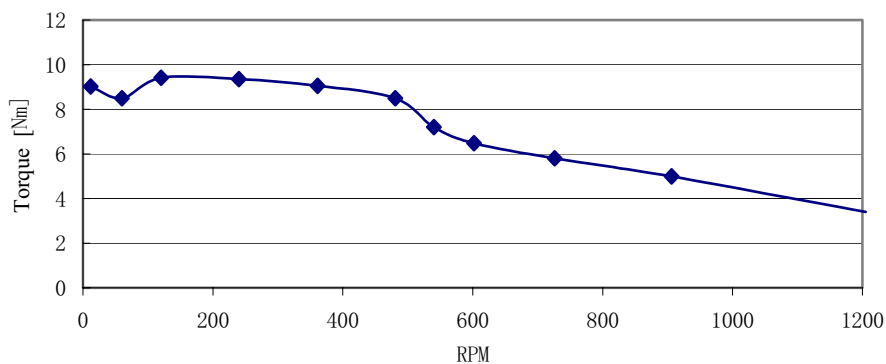

# FL57STHJB Gearbox Stepping Motor

**A42**

- **Motor Specifications**

Same as FL57STH series motor

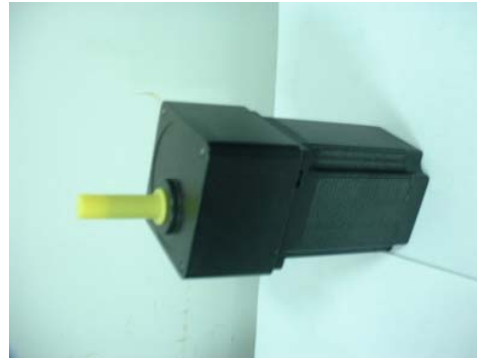

- **Gearbox Specifications**

Output shaft radial load 12kg

Output shaft thrust load 24kg

<b>Ratio</b>	3	7.5	12.5	15	25	30	50	75	90	100	120	150
<b>Number of gear trains</b>	2	2	2	3	3	3	4	4	5	5	5	5
<b>Length(L) mm</b>	32	32	32	32	42	42	42	42	42	42	42	42
<b>Peak torque kg.cm</b>	50											
<b>Average Backlash At Nolaod</b>	4 deg.			3.5 deg.			3 deg.			2.5deg		

- **Dimensions**

